

COVERSHEET

Planned document changes:

Briefly:

2024-10-07. Torque for POS.14: 8Nm.

Document changes:

Date:

Change:

Rev.

after change:

2024-03-13

New document.

-

Readers note:



Indicates instruction.



Represents Hose.

Dashed lines for overview, mounts
on other pages/assemblies.

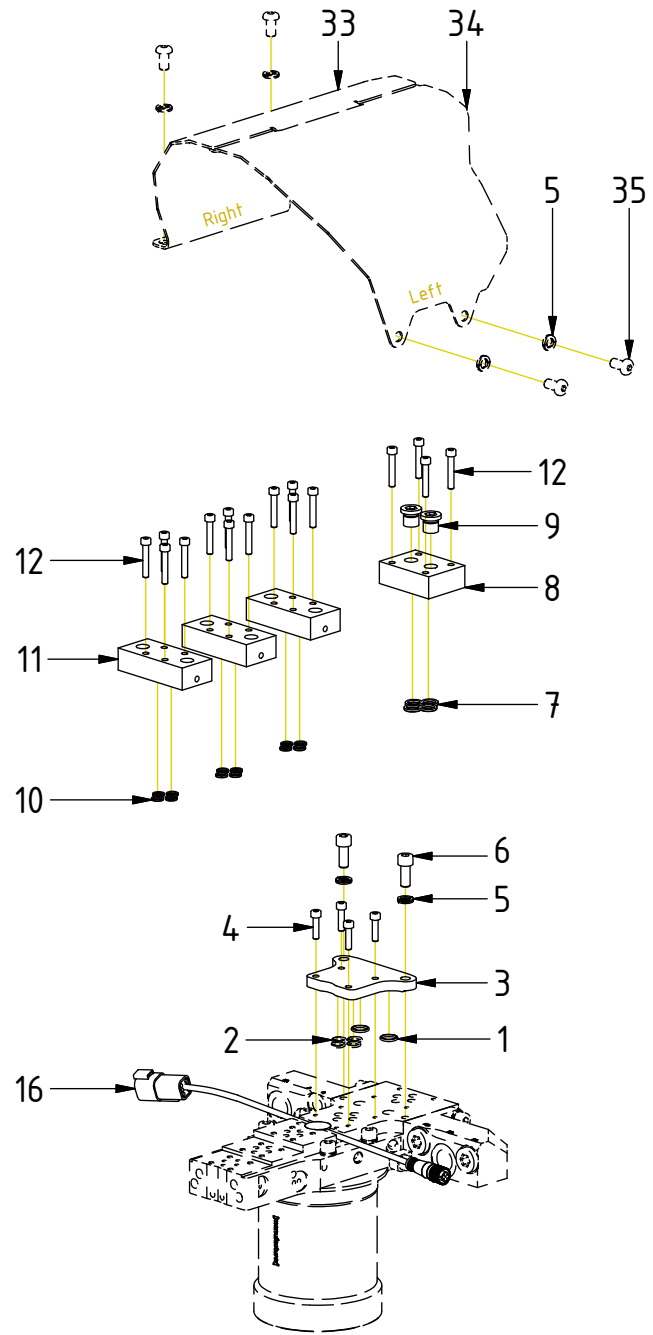

POS	DESCRIPTION	PART	QTY	COMMENTS
1	O-ring 12,42x1,78	710973	2	
2	O-ring 9,25x1,78	710901	4	
3	Cover plate valve block ss0	1070785	1	
4	Screw MC6S M5x20 12.9	610400	4	
5	Washer NL 8mm	611040	6	QTY: 4 part of make up
6	Screw MC6S M8x20 12.9 ZFSHL	6000157	6	
7	O-ring 10,77x2,62	710910	4	
8	Connection block 2x 1/4" NG6	400036	1	
9	Plug 153-04 (1/4")	711505	2	
10	O-ring 7,65x1,78	710960	12	
11	Connection block 2x1/4" NG4	1009586	3	
12	Screw MC6S M5x30 12.9	610403	16	Torque: 9,7Nm
13	Protection plate End lock EC206B	1062673	1	
14	Screw K6S M6x20 10.9 FZB	6000339	2	Torque: 79Nm
15	Cable QS QLM tiltrotator DTM 4,5m	842148	1	
16	Q-Safe connector			
33	Protective cover EC206B right	1060973	1	Part of make up
34	Protective cover EC206B left	1061668	1	Part of make up
35	Screw K6S M8x16 10.9 FZB	611810	4	Part of make up

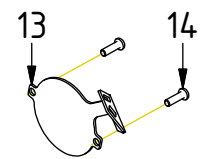
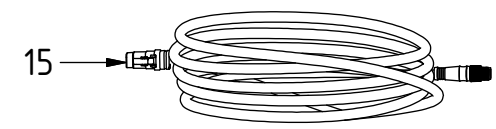

Hoses

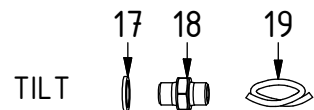
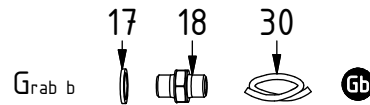
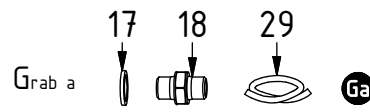
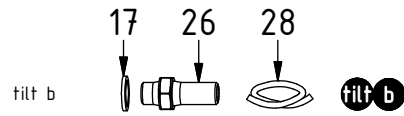
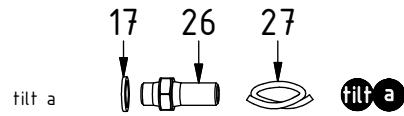
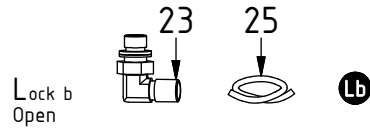
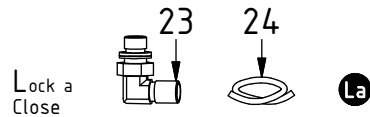
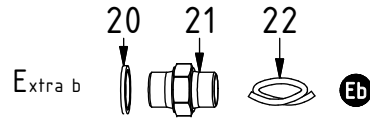
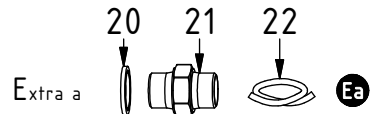

(FEED Rotation directly between motor & top part)

POS	DESCRIPTION	PART	QTY	COMMENTS
17	Washer GBR04 1/4	710702	6	
18	Adapter 138-04-29 (1/4")	710135	4	
19	Hose Tilt	7001694	2	
20	Washer GBR08 1/2	710704	2	
21	Adapter 136-08-08 (1/2")	710108	2	
22	Hose Feed	7001692	2	
23	Adapter 401-04-04 90° (1/4")	710151	2	
24	Hose feed Lock a	7001823	1	
25	Hose feed Lock b	7001824	1	
26	Adapter 1260-04-04 (1/4")	710240	2	
27	Hose feed tilt a	7001825	1	
28	Hose feed tilt b	7001826	1	
29	Hose feed Grab a	7001827	1	
30	Hose feed Grab b	7001828	1	
31	Hose Rotation a (ss0)	7001669	1	Part of quick hitch assy.
32	Hose Rotation b (ss0)	7001670	1	Part of quick hitch assy.

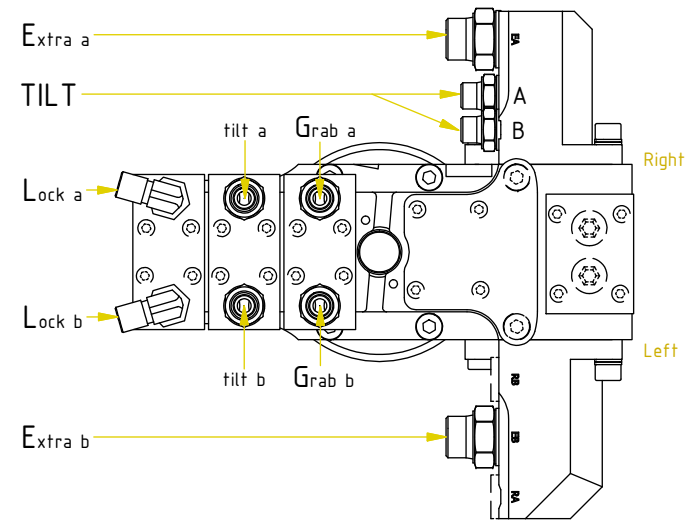

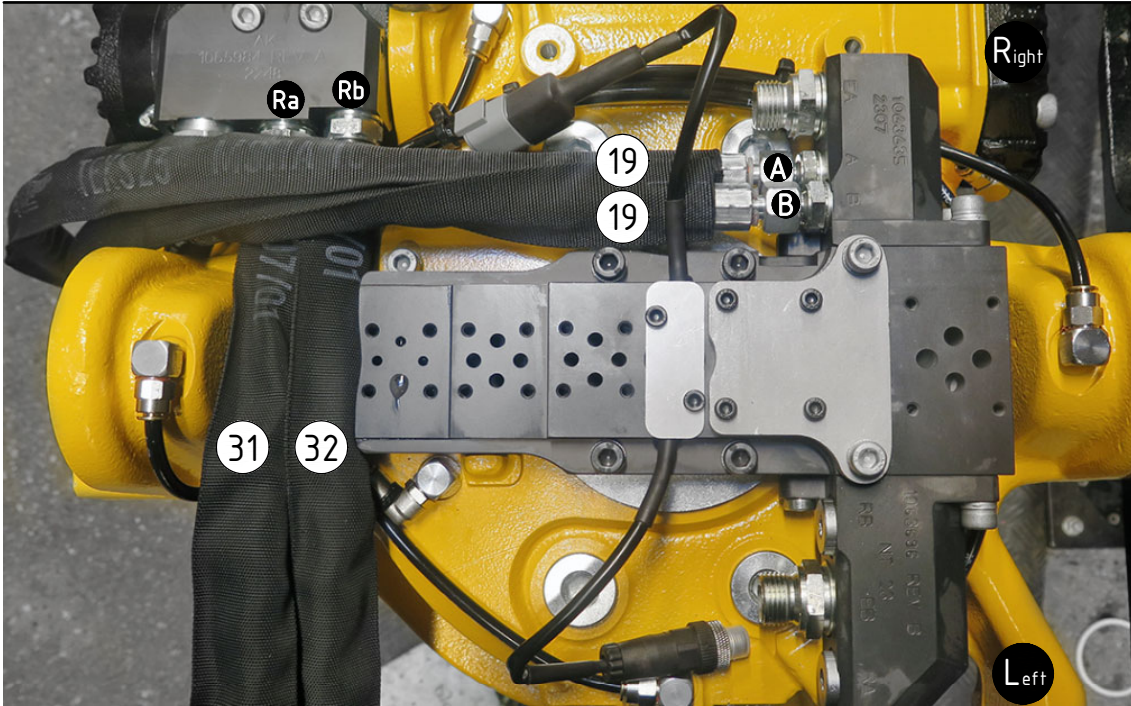

POS	DESCRIPTION	PART	QTY	COMMENTS
15	Cable QS QLM tiltrfator DTM 4,5m	842148	1	
16	Q-Safe connector			
19	Hose Tilt	7001694	2	
22	Hose Feed	7001692	2	
24	Hose feed Lock a	7001823	1	
25	Hose feed Lock b	7001824	1	
27	Hose feed tilt a	7001825	1	
28	Hose feed tilt b	7001826	1	
29	Hose feed Grab a	7001827	1	
30	Hose feed Grab b	7001828	1	
31	Hose Rotation a (ss0)	7001669	1	Part of quick hitch assy.
32	Hose Rotation b (ss0)	7001670	1	Part of quick hitch assy.
● Use cable ties				

