

Planned document changes:

Briefly:

Cables for ss0 (always w/o ECO): POS.17 & POS.20.

Document changes:

Date:	Change:	Rev. after change:
2025-11-06	Missing DC3 cables added.	J
2025-08-14	DC3 without EC-Oil added. EC204B-EC206B DC3 added.	I
2025-02-19	Photos added.	H
2024-11-05	EC204B cables added.	G
2023-10-24	EC209B-EC233 DC3 added.	F
2023-08-15	Photos added.	E
2023-03-14	Y-split replaced. Cables added.	D
2022-09-30	Glue info updated.	C
2022-08-31	Torque updated.	B
2022-06-14	Sensor clarification.	A
2022-05-11	New document.	-

Readers note:



Indicates instruction.



Represents Hose.

Dashed lines for overview, mounts
on other pages/assemblies.

EC204B

25-26
22-23

Exploded view
Std. Top components

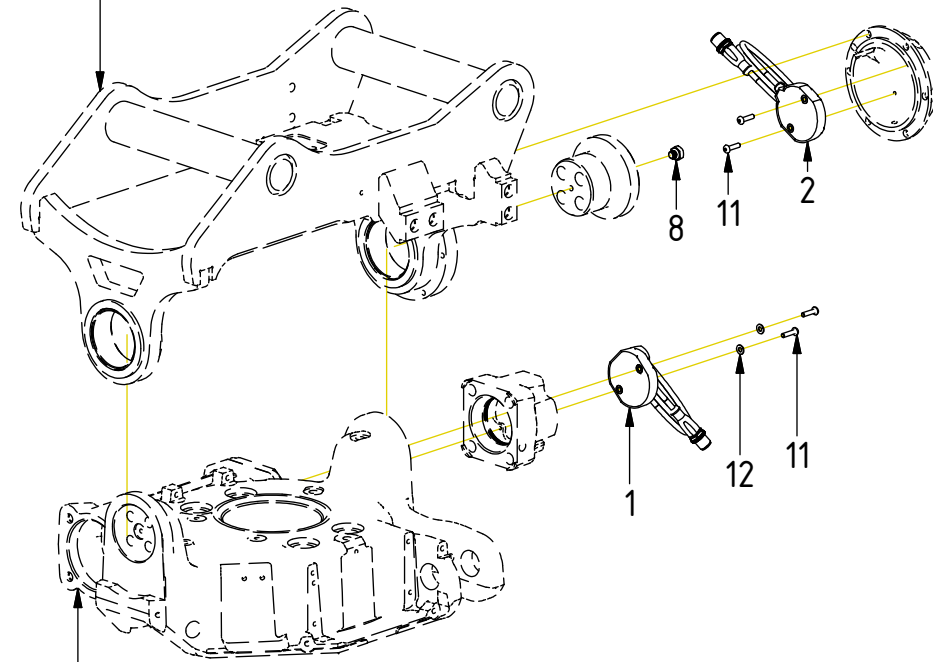

Exploded view
Rotator frame

POS	DESCRIPTION	PART	QTY	COMMENTS
1	Rotation sensor EC204B	8002455	1	White side towards magnet
2	Tilt angle sensor EC204B	8002467	1	White side towards magnet
3	Powerplug ECO40W Left 2xM12 204B	8002454	1	Part of EC-Oil components
4	Adapter cable tilt sensor EC204B	8002471	1	
5	Y-split EC204B	8002474	1	
6	Aggregate cable DC2 1xM12 EC204B	8002470	1	Part of control system
7	Adapter cable ss9 w. 120 ohm term.	8002495	1	
8	Magnet screw - Rot./Tilt sensor	8001547	2	Loxal 83-52. Torque: 10Nm QTY: 1 for EC204B
11	Screw K6S M4x16 10.9 FZB	6000368	4	Loxal 55-02
12	Washer BRB 4,3x9x0,8 200 HV FZB	6000127	2	
21	Nut M6M M5	6001920	1	For UNI. Use with POS.22
22	Screw MC6S 5x20 12.9	610400	1	For UNI
23	Screw MC6S 5x12 12.9	6000077	*	
25	Rubber steel clamp ø14	613009	*	
26	Rubber steel clamp ø6	6000027	*	

POS in order of assembly

DC3 EC-Oil:

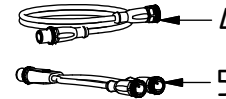

DC3 without EC-Oil:

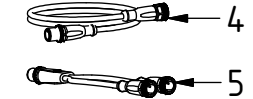

DC2 EC-Oil:

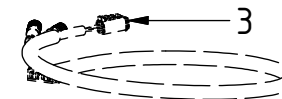

DC2 without EC-Oil:

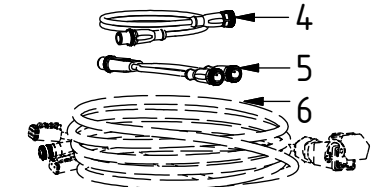

ss9/ss0 without EC-Oil:

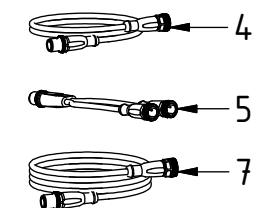

EC206B

- 25
- 24

POS	DESCRIPTION	PART	QTY	COMMENTS
8	Magnet screw - Rot./Tilt sensor	8001547	2	Loxeal 83-52. Torque: 10Nm QTY: 1 for EC204B
9	Rotation sensor	8001543	1	White side towards magnet
10	Tilt angle sensor	8001544	1	White side towards magnet
11	Screw K6S M4x16 10.9 FZB	6000368	4	Loxeal 55-02
13	Adapter cable tilt sensor 600mm	8001610	1	For EC206B-EC209B
15	Powerplug ECO40W Left 2xM12 206B	8001885	1	Part of EC-Oil components
17	Y-split M12 EVC614	1069559	1	
18	Adapter cable DC2	8000783	1	
20	Ad.cable ss9/SVAB w. 120 ohm ter.	8000824	1	
24	Screw K6S M5x8 10.9 FZB	611801	*	
25	Rubber steel clamp \varnothing 14	613009	*	

POS in order of assembly

Exploded view
Std. Top components

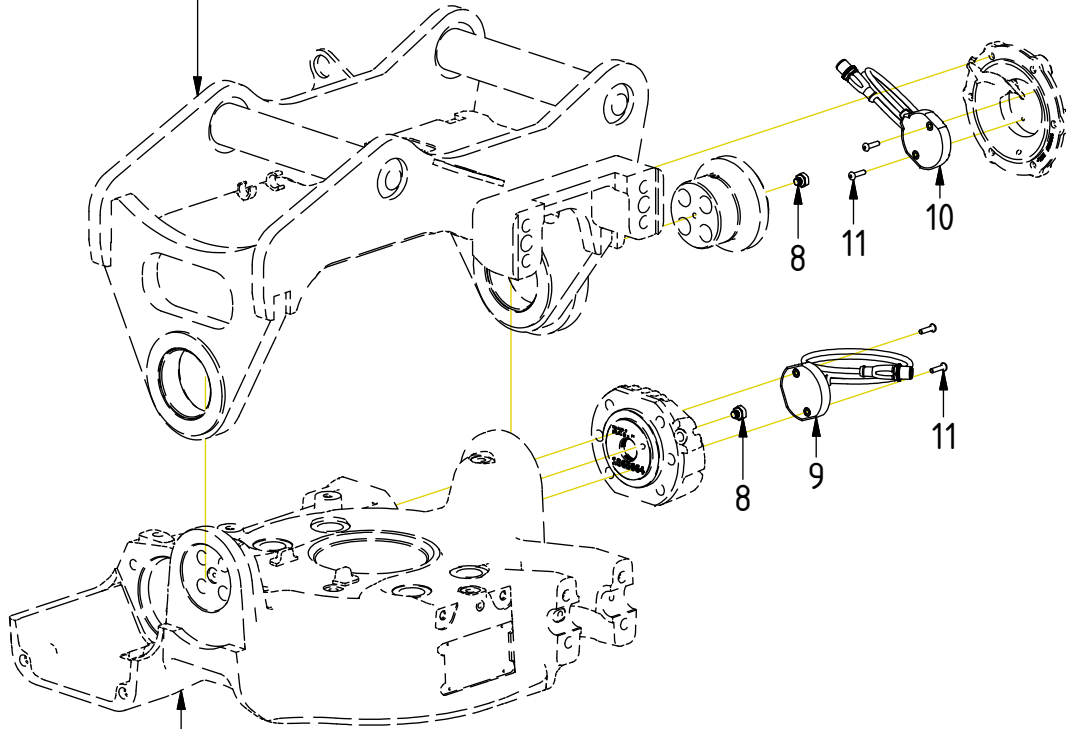

Exploded view
Rotator frame

DC3 EC-Oil:

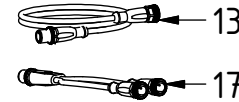

DC3 without EC-Oil:

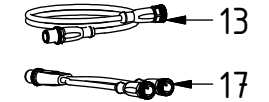

DC2 EC-Oil:

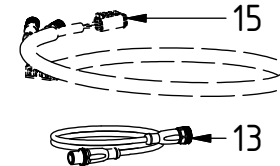

DC2 without EC-Oil:

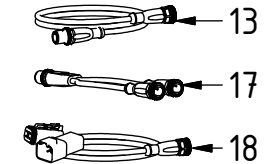

ss9/ss10(SVAB)/ss0 w/o ECO:

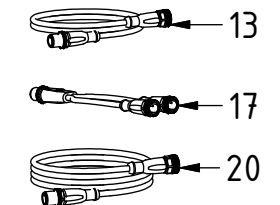

EC209B-EC233

- 25
- 24

POS	DESCRIPTION	PART	QTY	COMMENTS
8	Magnet screw - Rot./Tilt sensor	8001547	2	Loxeal 83-52. Torque: 10Nm QTY: 1 for EC204B
9	Rotation sensor	8001543	1	White side towards magnet
10	Tilt angle sensor	8001544	1	White side towards magnet
11	Screw K6S M4x16 10.9 FZB	6000368	4	Loxeal 55-02
13	Adapter cable tilt sensor 600mm	8001610	1	For EC206B-EC209B
14	Adapter cable tilt sensor 1200mm	8001611	1	For EC214-EC233
16	Adapter cable ECO W DC2 ePS2	8001847	1	Part of Control system
17	Y-split M12 EVC614	1069559	1	
18	Adapter cable DC2	8000783	1	
19	Ad.cable ss9/SVAB ECOw 120 ohm	8000825	1	
20	Ad.cable ss9/SVAB w. 120 ohm ter.	8000824	1	
24	Screw K6S M5x8 10.9 FZB	611801	*	
25	Rubber steel clamp \varnothing 14	613009	*	

POS in order of assembly

Exploded view
Std. Top components

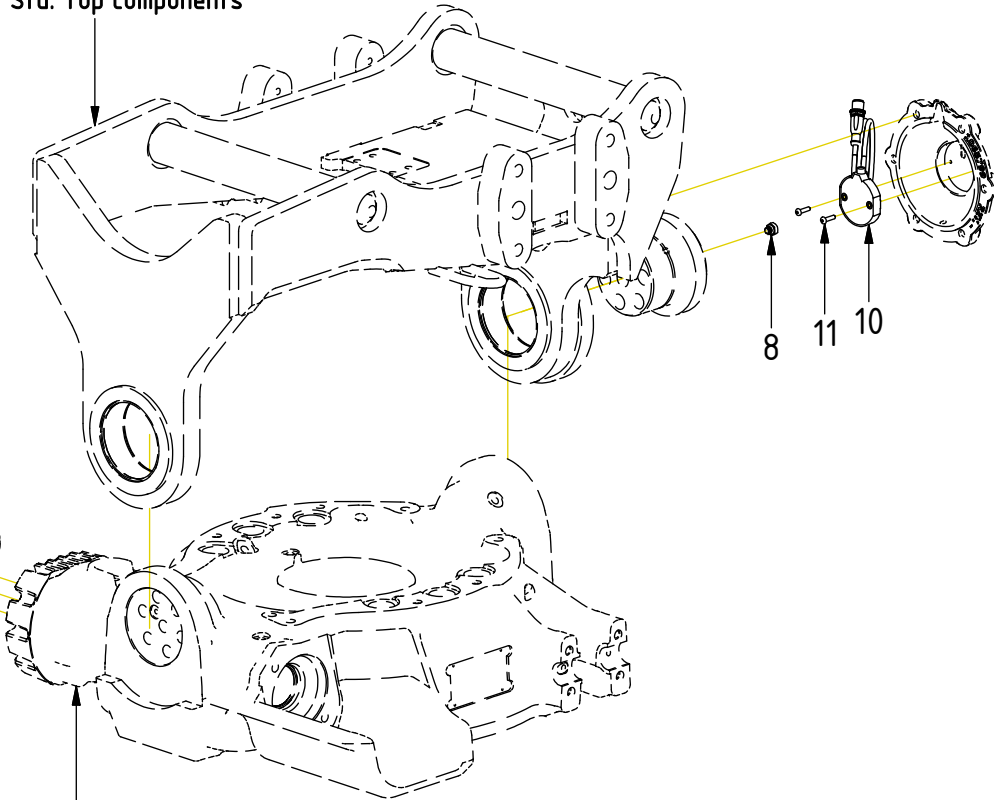

Exploded view
Rotator frame

DC3 EC-Oil:

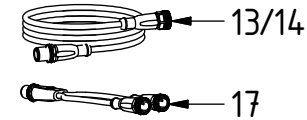

DC3 without EC-Oil:

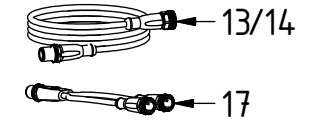

DC2 EC-Oil:

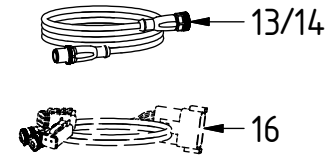

DC2 without EC-Oil:

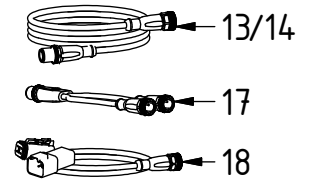

ss9/ss10(SVAB) EC-Oil:

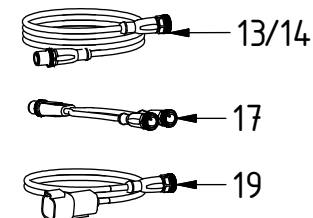

ss9/ss10(SVAB) w/o EC-Oil:

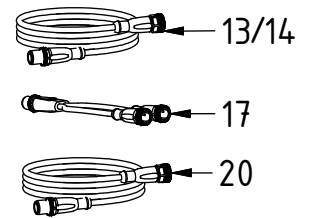

EC204B
DC3 EC-Oil

POS	DESCRIPTION	PART	QTY	COMMENTS
1	Rotation sensor EC204B	8002455	1	White side towards magnet
2	Tilt angle sensor EC204B	8002467	1	White side towards magnet
3	Powerplug ECO40W Left 2xM12 204B	8002454	1	Part of EC-Oil components
4	Adapter cable tilt sensor EC204B	8002471	1	
5	Y-split EC204B	8002474	1	
6	Aggregate cable DC2 1xM12 EC204B	8002470	1	Part of control system
7	Adapter cable ss9 w. 120 ohm term.	8002495	1	
25	Rubber steel clamp ø14	613009	*	
26	Rubber steel clamp ø6	6000027	*	

POS in order of assembly

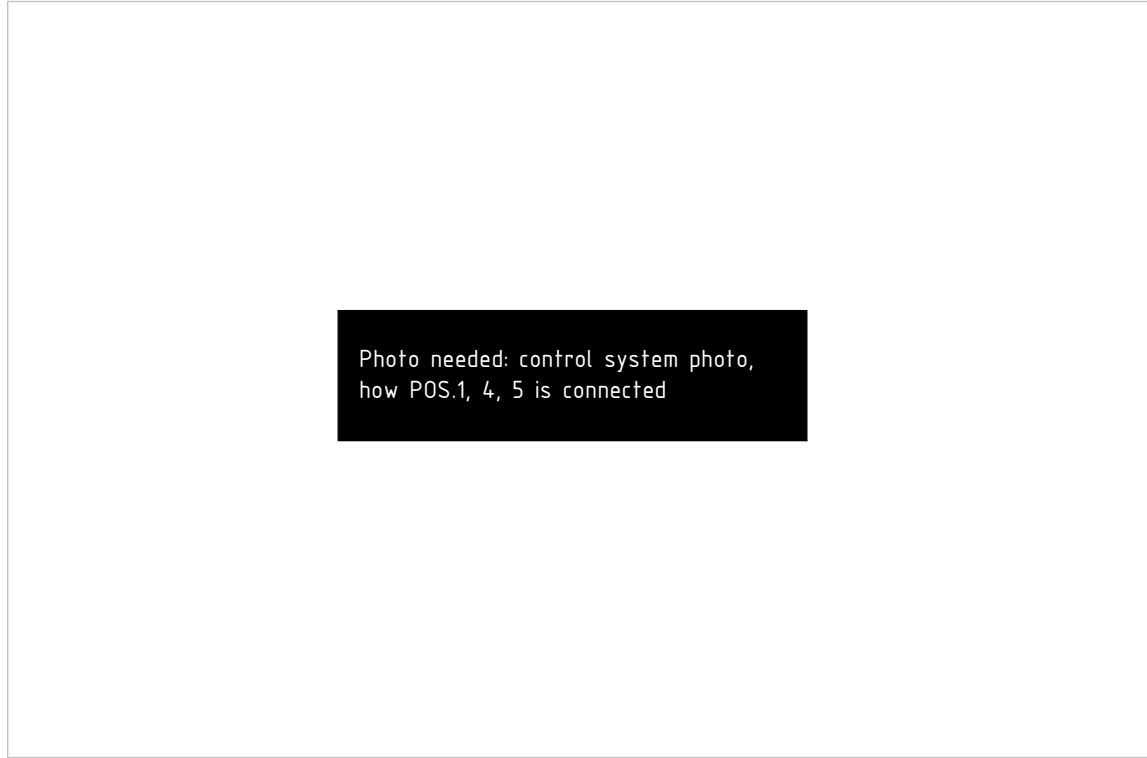

Photo needed: control system photo,
how POS.1, 4, 5 is connected



DC3 without EC-Oil:

Photo needed: control system photo,
how POS.1, 4, 5 is connected

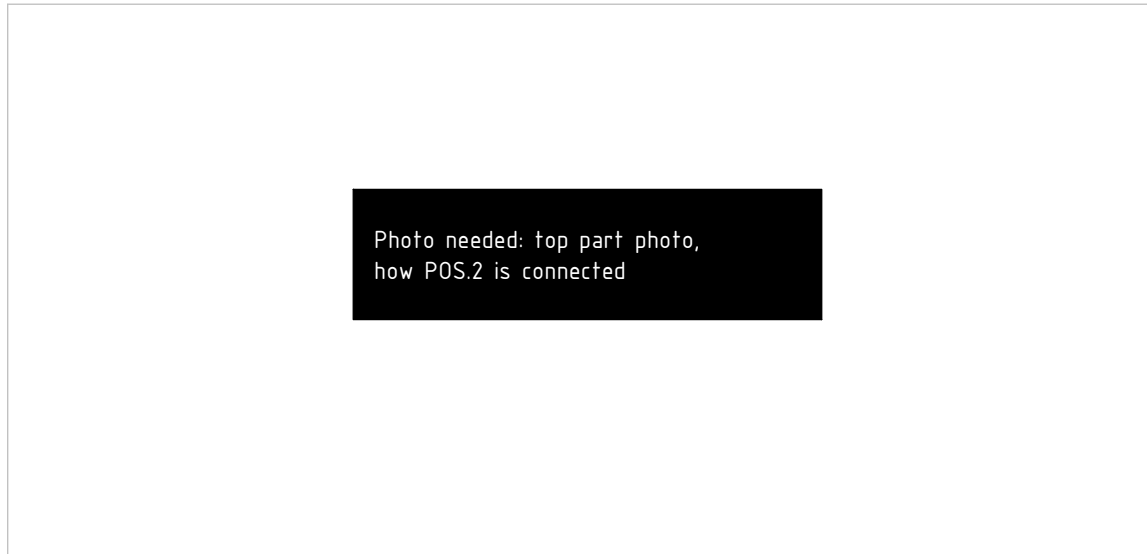

Photo needed: top part photo,
how POS.2 is connected

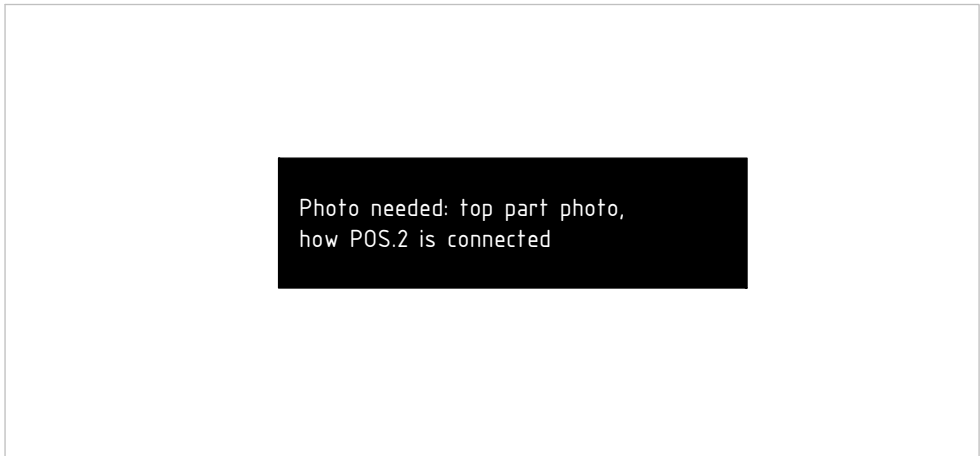
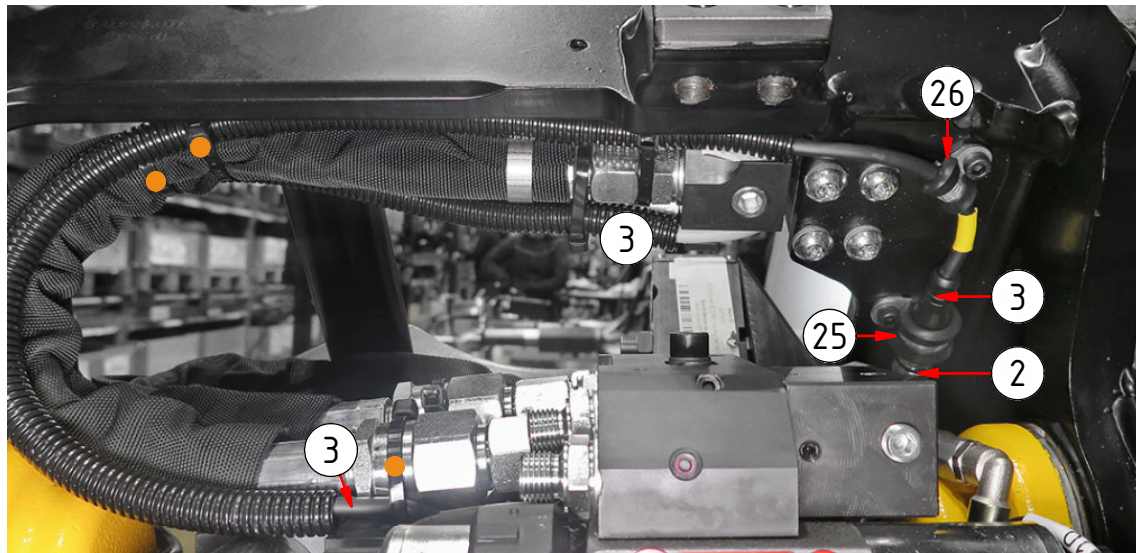
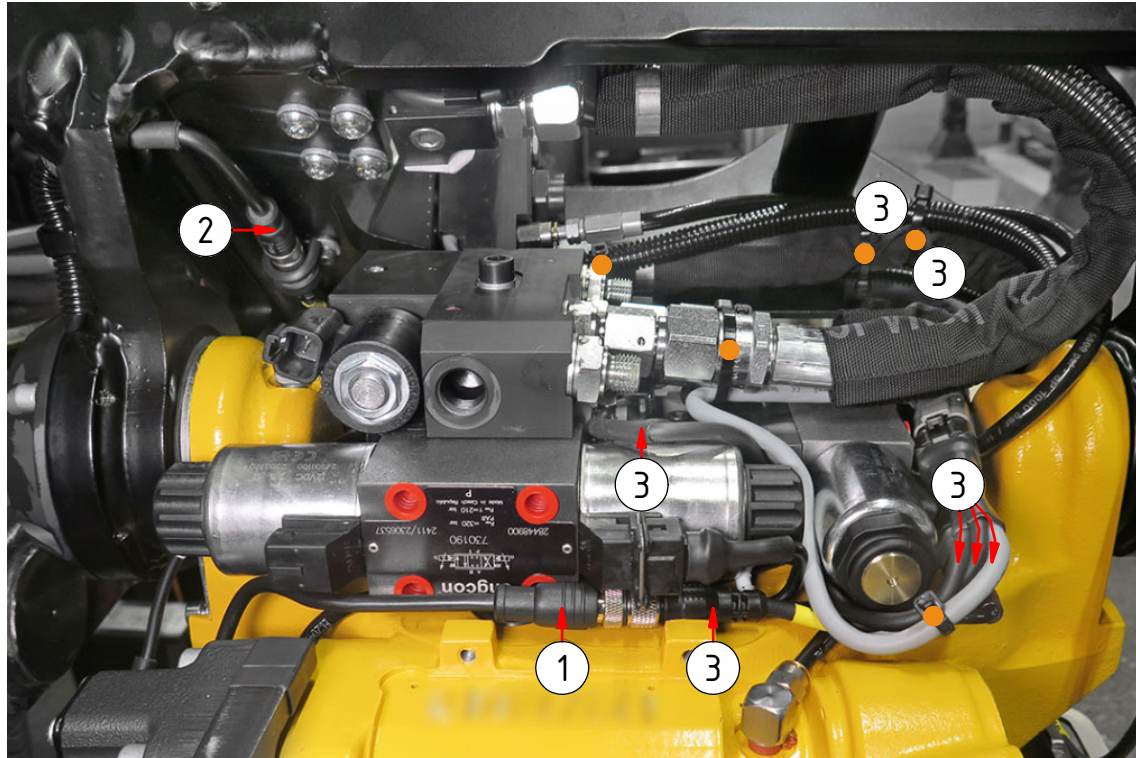

Photo needed: top part photo,
how POS.2 is connected

EC204B
DC2 EC-Oil



POS	DESCRIPTION	PART	QTY	COMMENTS
1	Rotation sensor EC204B	8002455	1	White side towards magnet
2	Tilt angle sensor EC204B	8002467	1	White side towards magnet
3	Powerplug ECO40W Left 2xM12 204B	8002454	1	Part of EC-Oil components
4	Adapter cable tilt sensor EC204B	8002471	1	
5	Y-split EC204B	8002474	1	
6	Aggregate cable DC2 1xM12 EC204B	8002470	1	Part of control system
7	Adapter cable ss9 w. 120 ohm term.	8002495	1	
25	Rubber steel clamp ø14	613009	*	
26	Rubber steel clamp ø6	6000027	*	
●	Use cable ties			

POS in order of assembly

DC2 without EC-Oil:

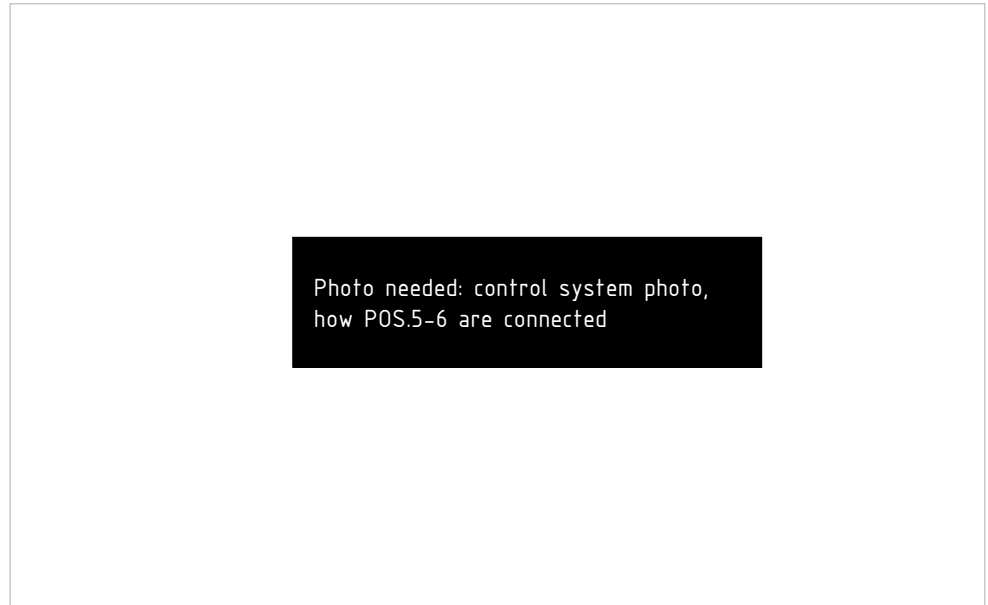

EC206B
DC3 EC-Oil

POS	DESCRIPTION	PART	QTY	COMMENTS
9	Rotation sensor	8001543	1	White side towards magnet
10	Tilt angle sensor	8001544	1	White side towards magnet
13	Adapter cable tilt sensor 600mm	8001610	1	For EC206B-EC209B
17	Y-split M12 EVC614	1069559	1	
25	Rubber steel clamp ø14	613009	*	

POS in order of assembly

Photo needed: control system photo,
how POS.9, 13, 17 is connected

DC3 without EC-Oil:

Photo needed: control system photo,
how POS.9, 13, 17 is connected

Photo needed: top part photo,
how POS.10 is connected

Photo needed: top part photo,
how POS.10 is connected

EC206B
DC2 EC-Oil

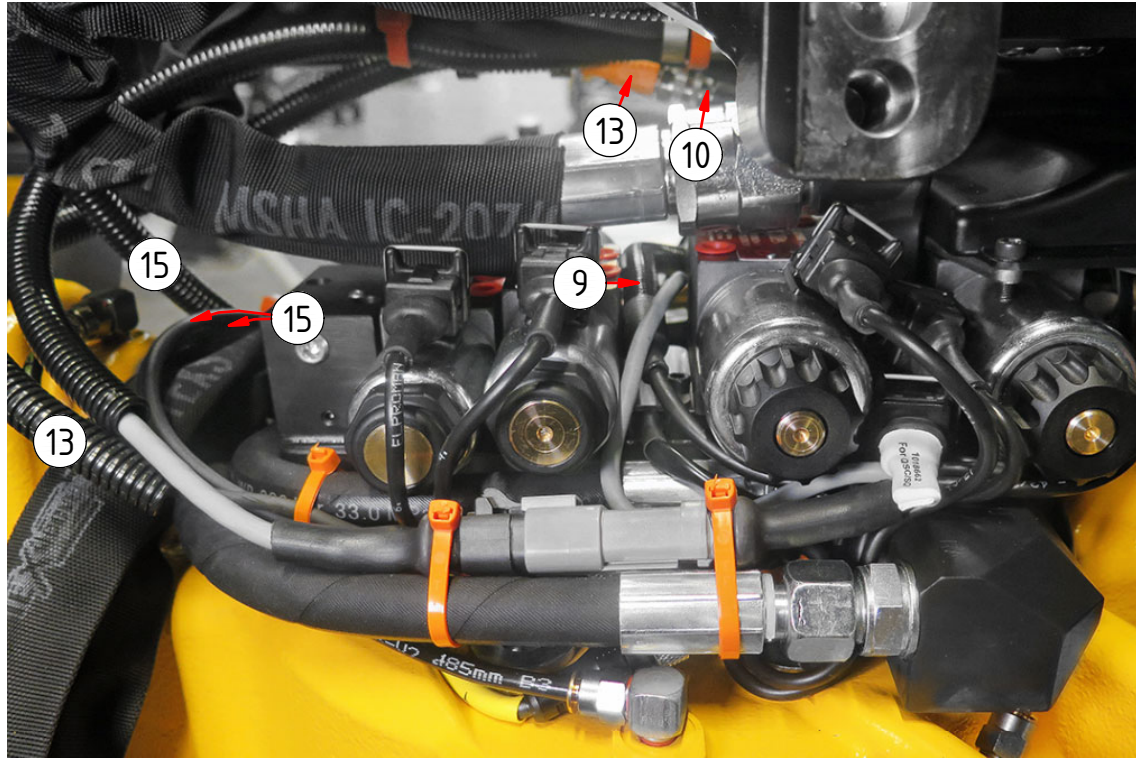

POS	DESCRIPTION	PART	QTY	COMMENTS
9	Rotation sensor	8001543	1	White side towards magnet
10	Tilt angle sensor	8001544	1	White side towards magnet
13	Adapter cable tilt sensor 600mm	8001610	1	For EC206B-EC209B
15	Powerplug ECO40W Left 2xM12 206B	8001885	1	Part of EC-Oil components
17	Y-split M12 EVC614	1069559	1	
18	Adapter cable DC2	8000783	1	
25	Rubber steel clamp ø14	613009	*	
●	Use cable ties			

POS in order of assembly

DC2 without EC-Oil:

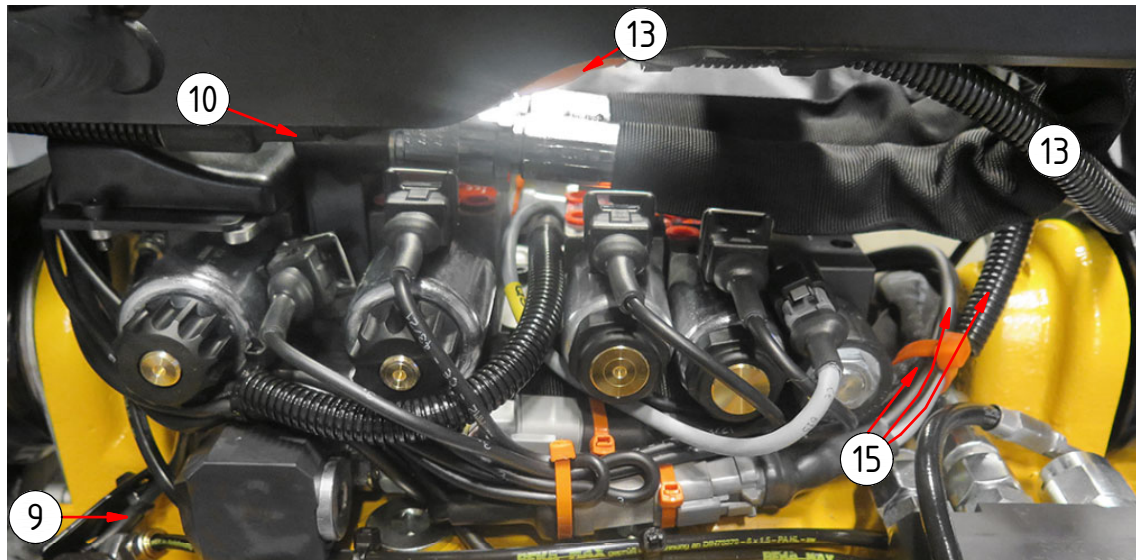
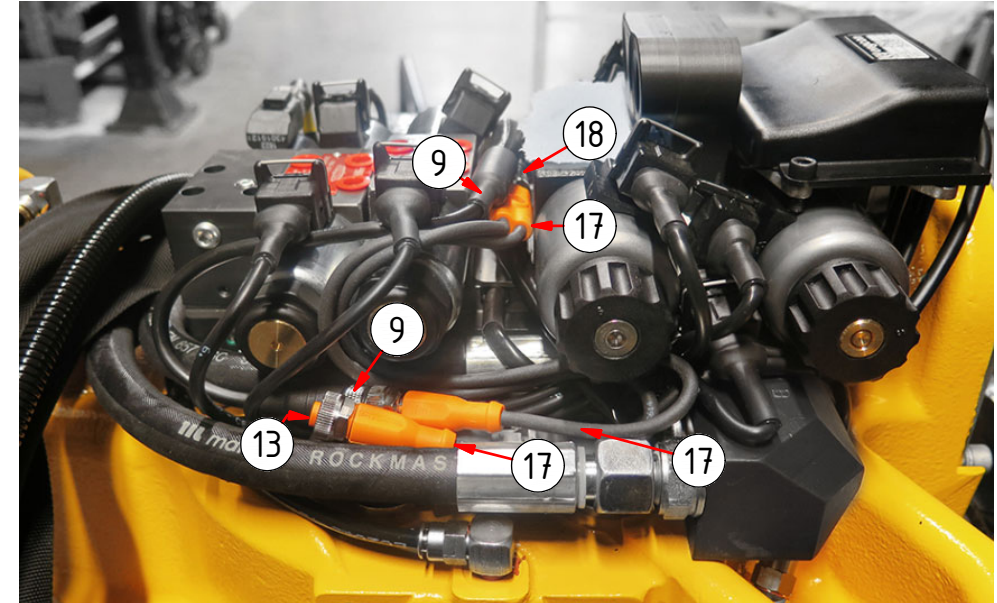

UNI:

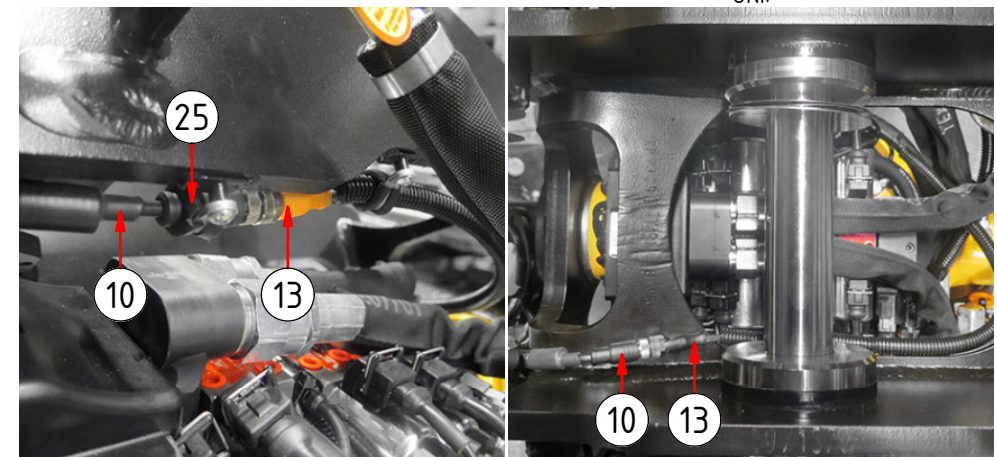

EC206B

ss9/ss10 (SVAB) EC-Oil

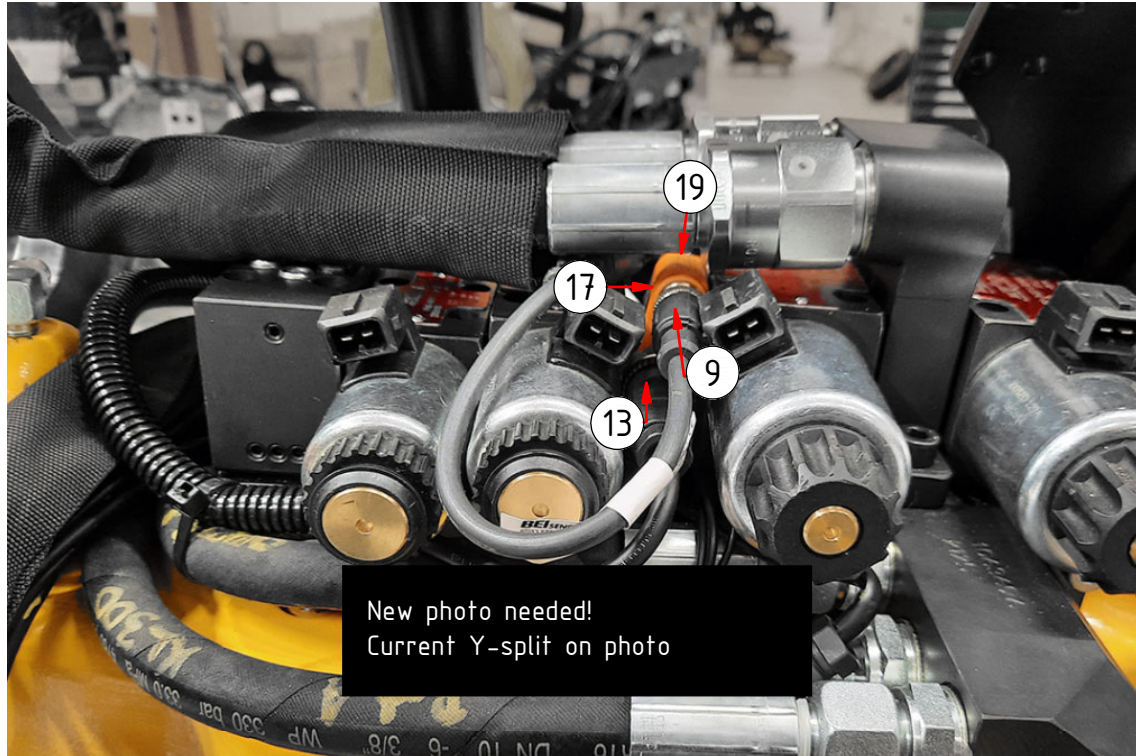

POS	DESCRIPTION	PART	QTY	COMMENTS
9	Rotation sensor	8001543	1	White side towards magnet
10	Tilt angle sensor	8001544	1	White side towards magnet
13	Adapter cable tilt sensor 600mm	8001610	1	For EC206B-EC209B
17	Y-split M12 EVC614	1069559	1	
19	Ad.cable ss9/SVAB ECOW 120 ohm	8000825	1	
20	Ad.cable ss9/SVAB w. 120 ohm ter.	8000824	1	

POS in order of assembly

ss9/ss10 (SVAB)/ss0 without EC-Oil:

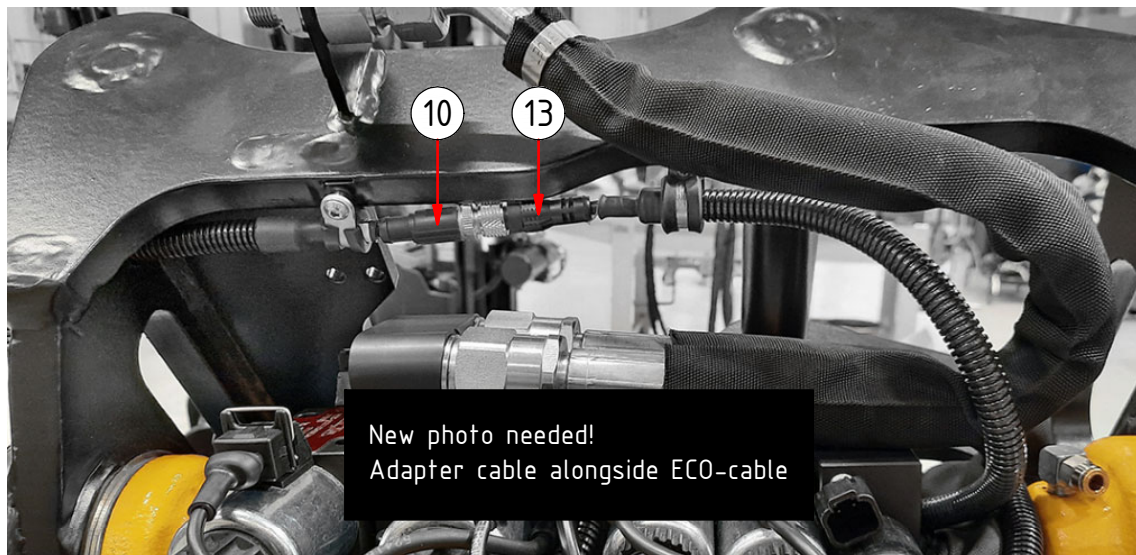
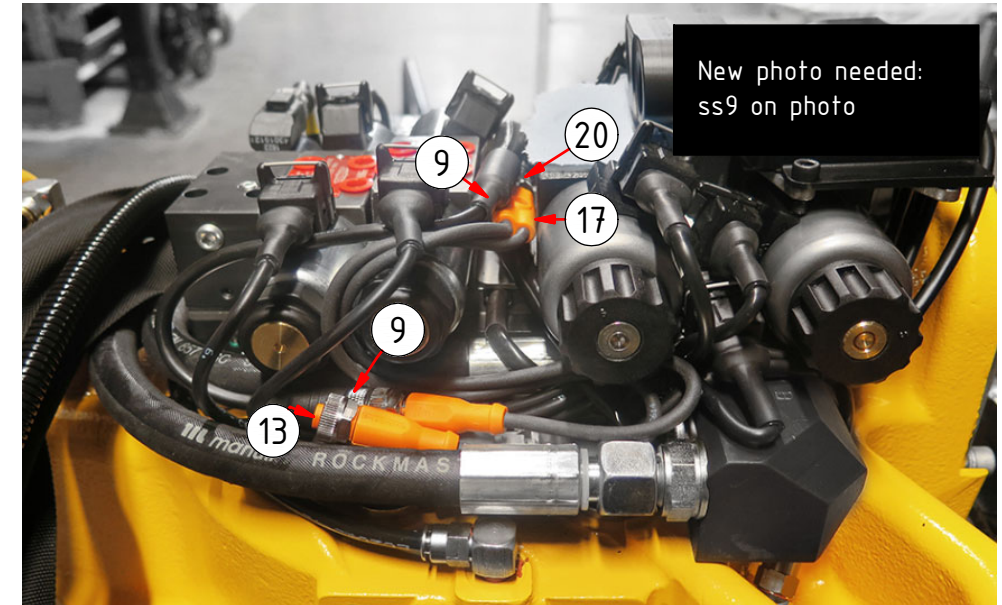

UNI:

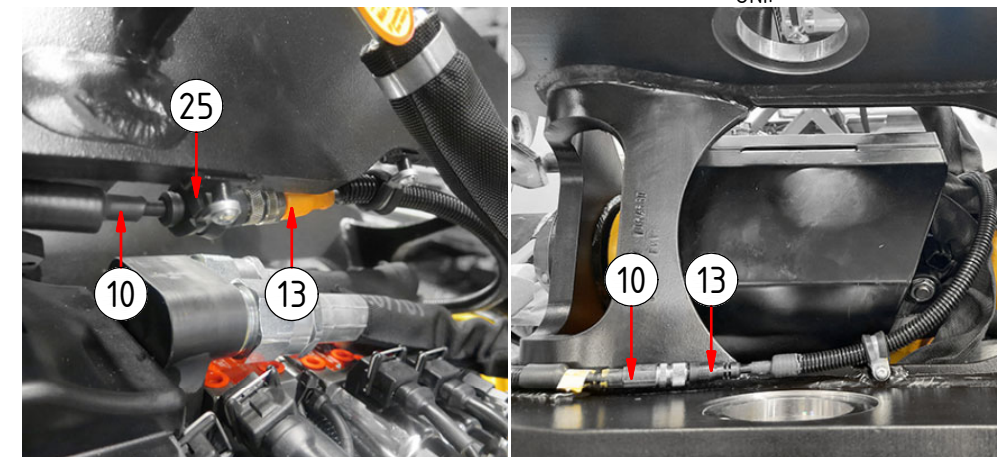

EC209B

DC3 EC-Oil

POS	DESCRIPTION	PART	QTY	COMMENTS
9	Rotation sensor	8001543	1	White side towards magnet
10	Tilt angle sensor	8001544	1	White side towards magnet
13	Adapter cable tilt sensor 600mm	8001610	1	For EC206B-EC209B
17	Y-split M12 EVC614	1069559	1	

POS in order of assembly

Photo needed: control system photo,
how POS.9, 13, 17 is connected

DC3 without EC-Oil:

Photo needed: control system photo,
how POS.9, 13, 17 is connected

Photo needed: top part photo,
how POS.10 is connected

Photo needed: top part photo,
how POS.10 is connected

EC209B
DC2 EC-Oil

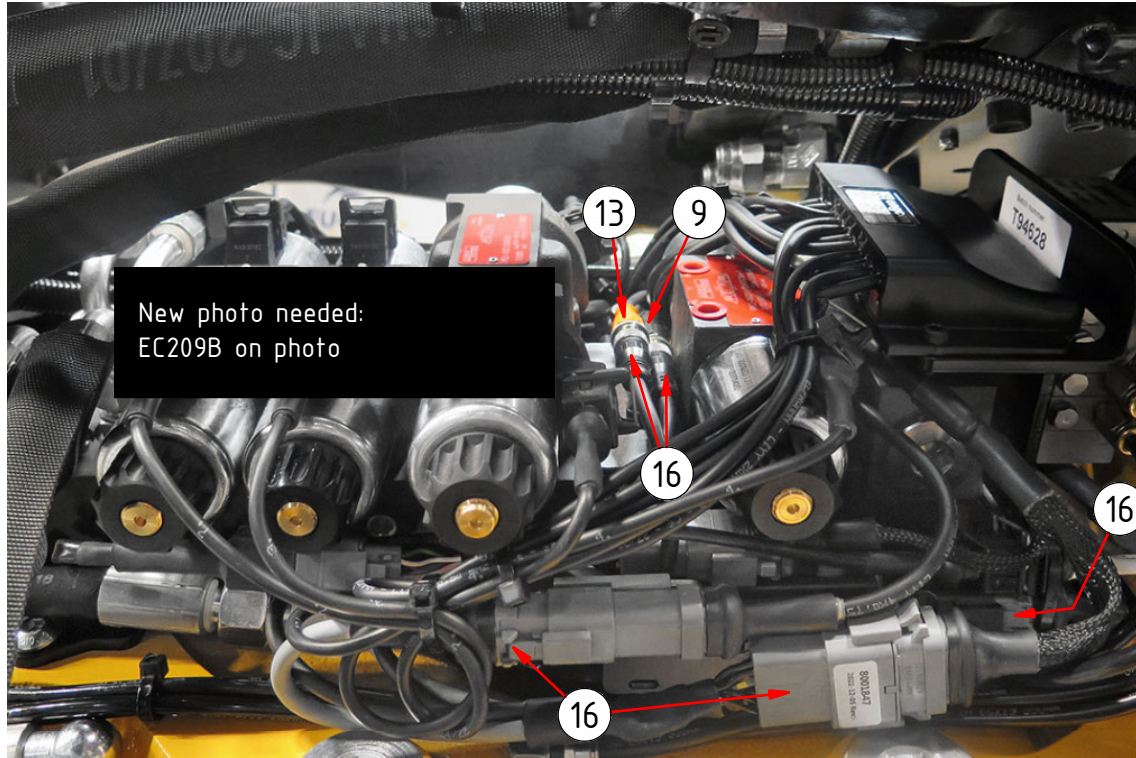

POS	DESCRIPTION	PART	QTY	COMMENTS
9	Rotation sensor	8001543	1	White side towards magnet
10	Tilt angle sensor	8001544	1	White side towards magnet
13	Adapter cable tilt sensor 600mm	8001610	1	For EC206B-EC209B
16	Adapter cable ECO W DC2 ePS2	8001847	1	Part of Control system
17	Y-split M12 EVC614	1069559	1	
18	Adapter cable DC2	8000783	1	
25	Rubber steel clamp $\varnothing 14$	613009	*	
●	Use cable ties			

POS in order of assembly

DC2 without EC-Oil:

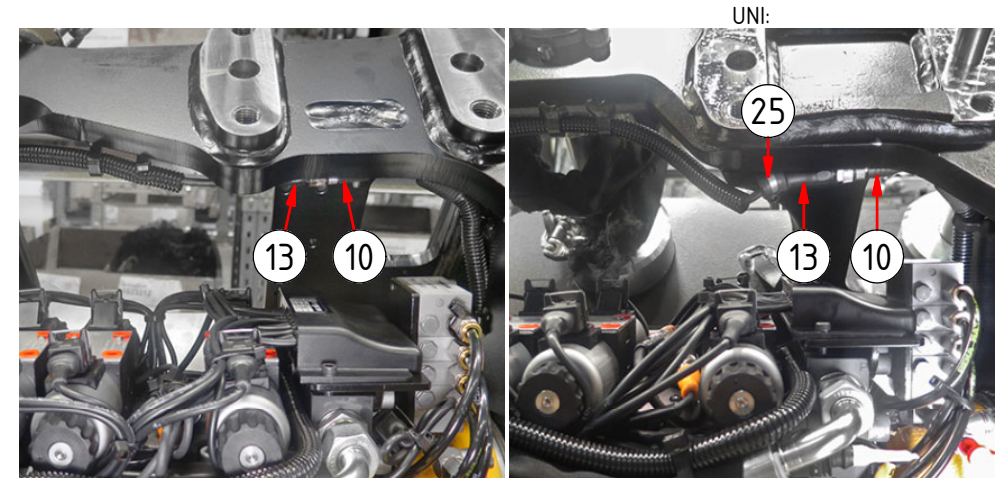
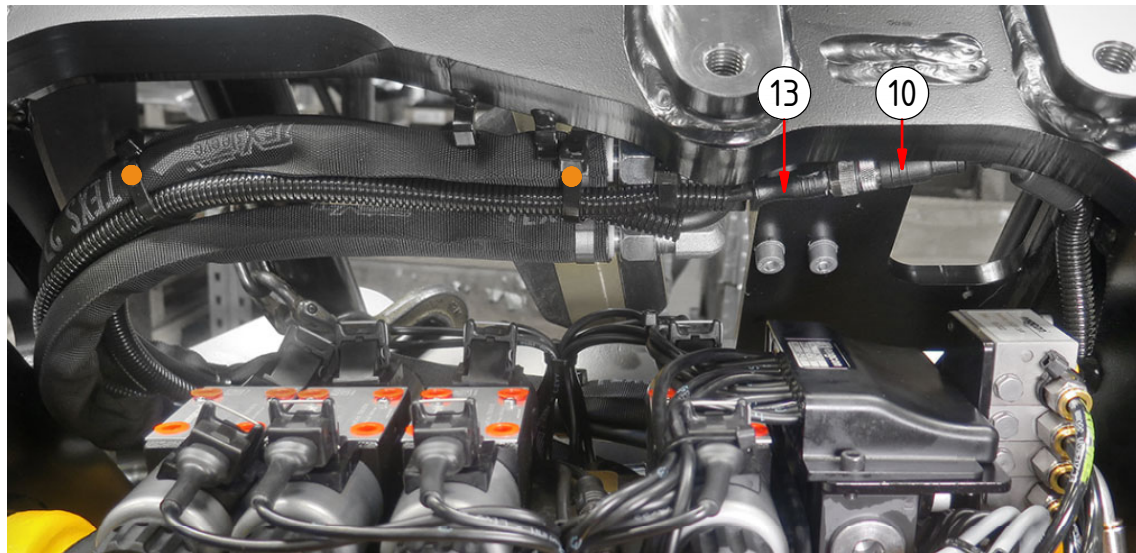
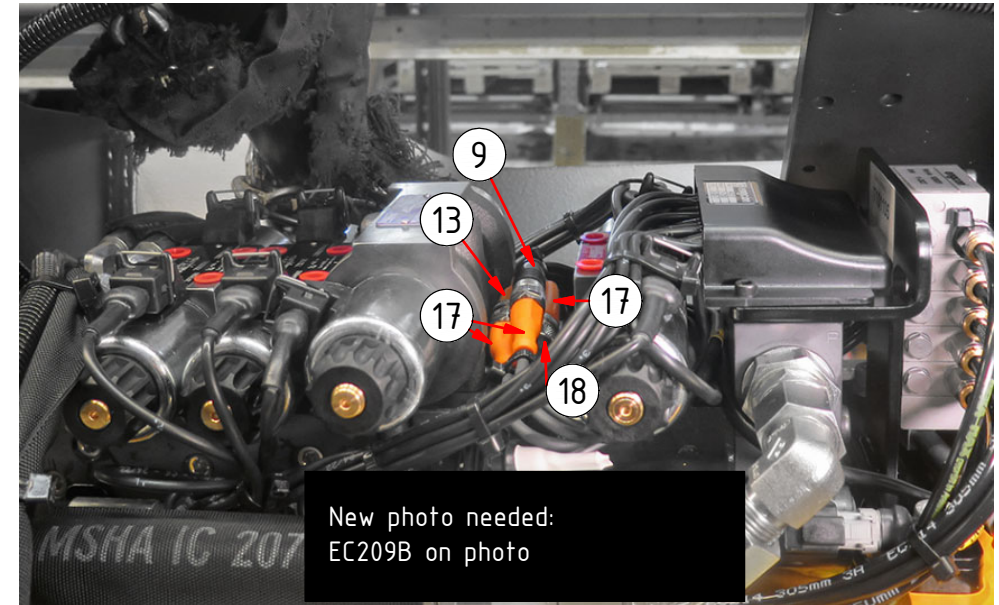

EC209B

ss9/ss10 (SVAB) EC-Oil

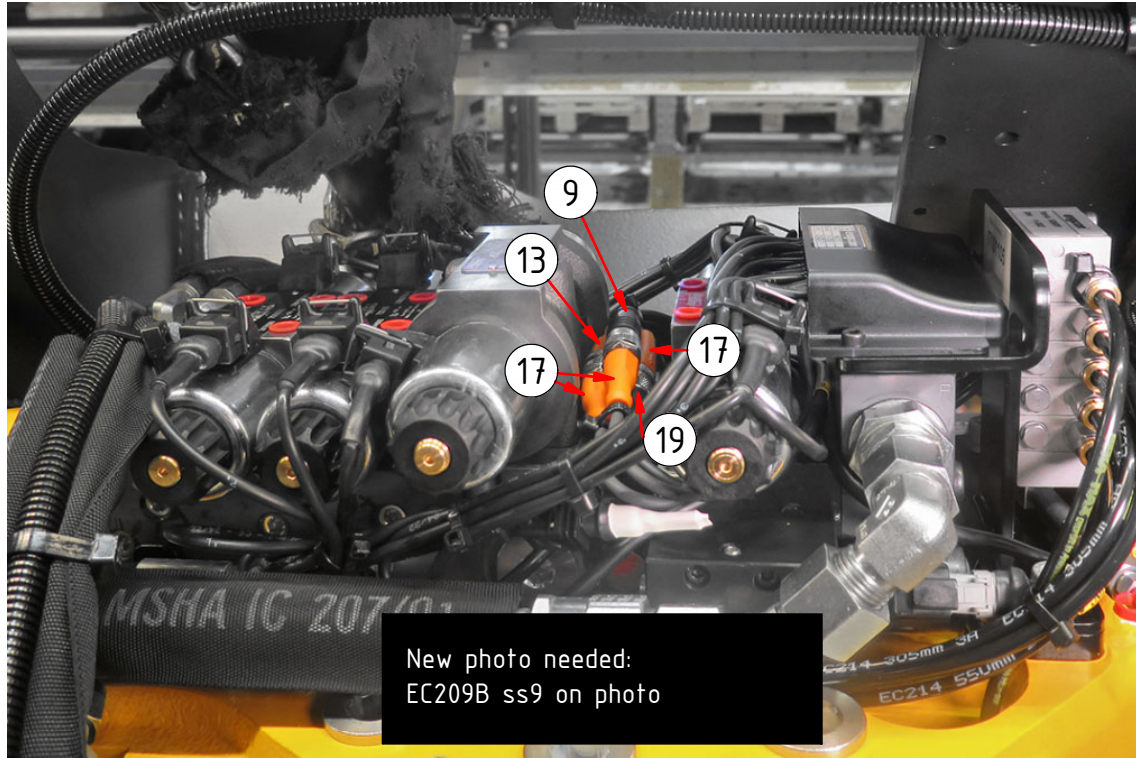

POS	DESCRIPTION	PART	QTY	COMMENTS
9	Rotation sensor	8001543	1	White side towards magnet
10	Tilt angle sensor	8001544	1	White side towards magnet
13	Adapter cable tilt sensor 600mm	8001610	1	For EC206B-EC209B
17	Y-split M12 EVC614	1069559	1	
19	Ad.cable ss9/SVAB ECOW 120 ohm	8000825	1	
20	Ad.cable ss9/SVAB w. 120 ohm ter.	8000824	1	
25	Rubber steel clamp \varnothing 14	613009	*	
●	Use cable ties			

POS in order of assembly

ss9/ss10 (SVAB) without EC-Oil:

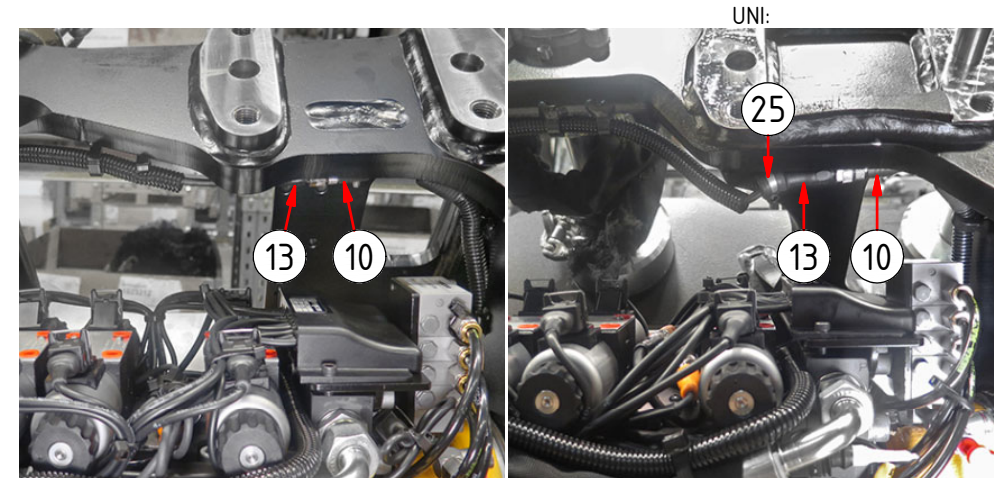
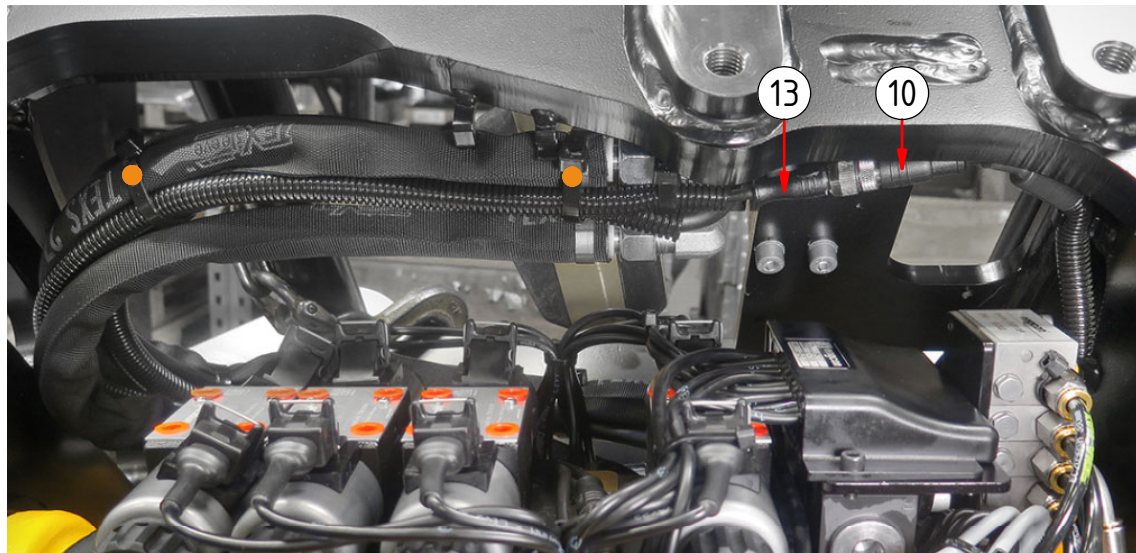
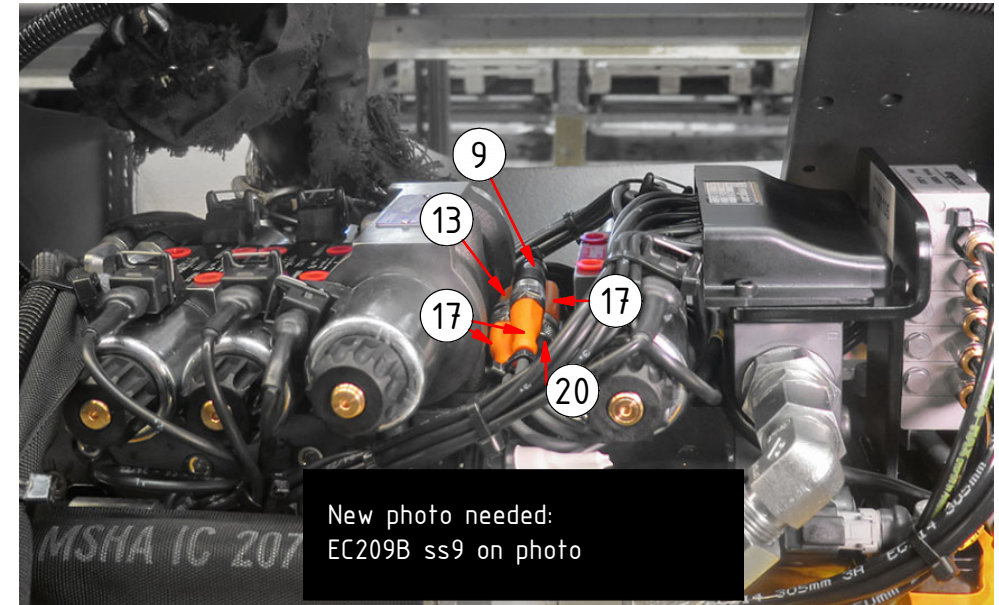

EC214-EC233
DC3 EC-Oil

POS	DESCRIPTION	PART	QTY	COMMENTS
9	Rotation sensor	8001543	1	White side towards magnet
10	Tilt angle sensor	8001544	1	White side towards magnet
14	Adapter cable tilt sensor 1200mm	8001611	1	For EC214-EC233
17	Y-split M12 EVC614	1069559	1	

POS in order of assembly

Photo needed: control system photo,
how POS.9, 14, 17 is connected

DC3 without EC-Oil:

Photo needed: control system photo,
how POS.9, 14, 17 is connected

Photo needed: top part photo,
how POS.10 is connected

Photo needed: top part photo,
how POS.10 is connected

EC214-EC219

DC2 EC-Oil

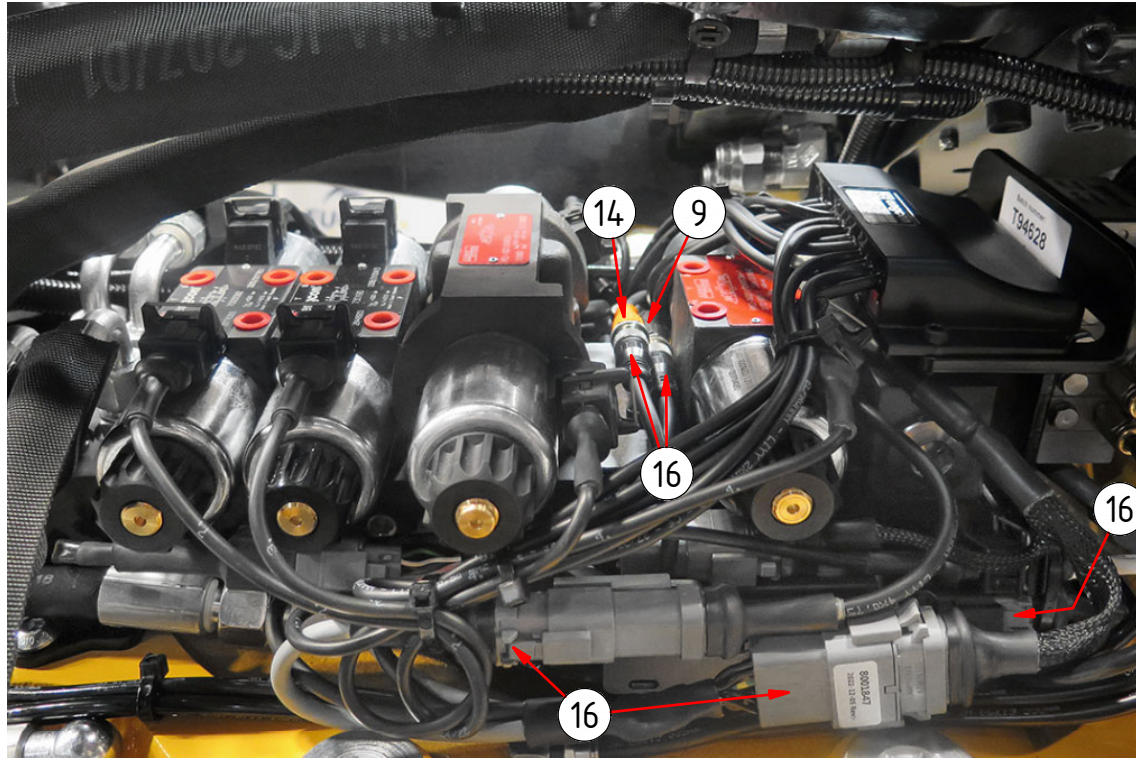

POS	DESCRIPTION	PART	QTY	COMMENTS
9	Rotation sensor	8001543	1	White side towards magnet
10	Tilt angle sensor	8001544	1	White side towards magnet
14	Adapter cable tilt sensor 1200mm	8001611	1	For EC214-EC233
16	Adapter cable ECO W DC2 ePS2	8001847	1	Part of Control system
17	Y-split M12 EVC614	1069559	1	
18	Adapter cable DC2	8000783	1	
25	Rubber steel clamp \varnothing 14	613009	*	
● Use cable ties				

POS in order of assembly

DC2 without EC-Oil:

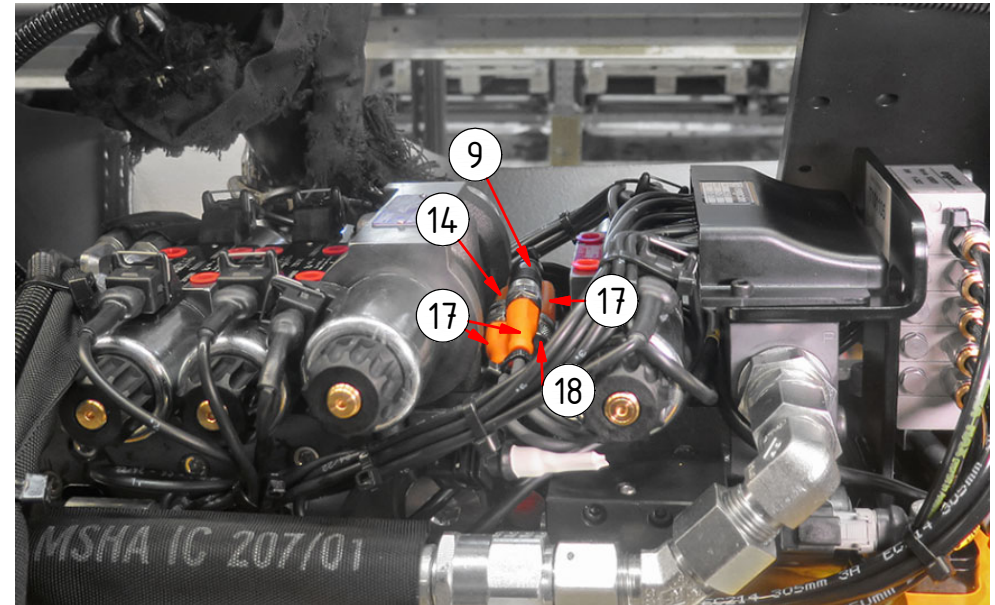

EC214:

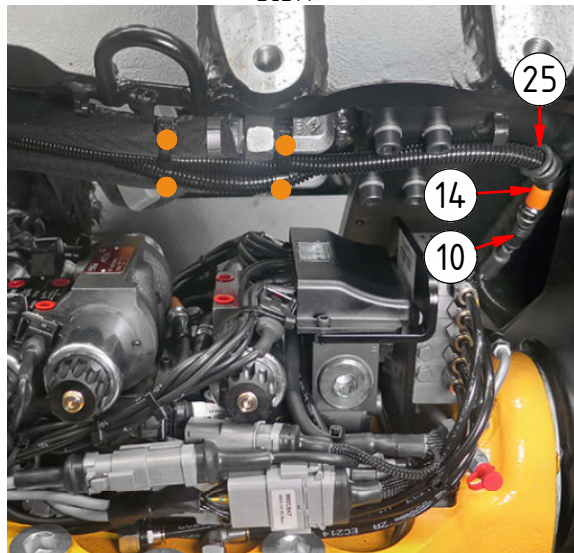

EC219:

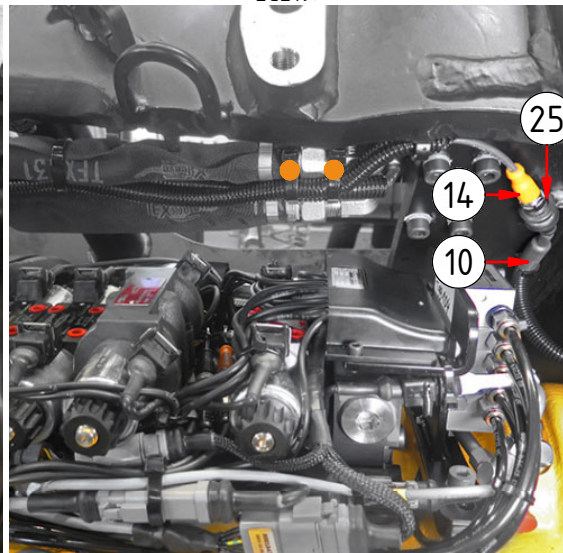

EC214:

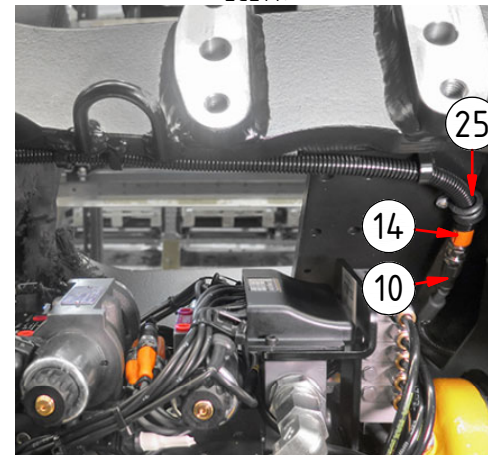

EC219:

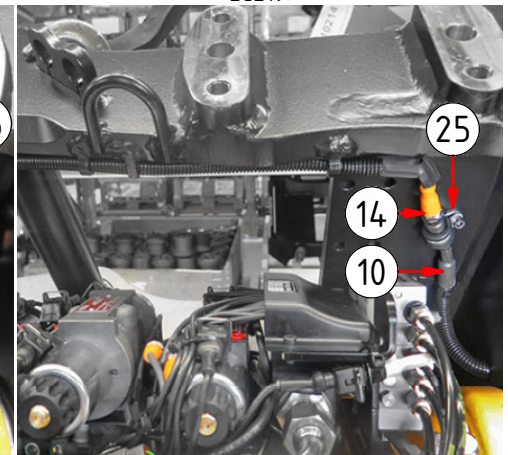

EC214-EC219

ss9/ss10 (SVAB) EC-Oil

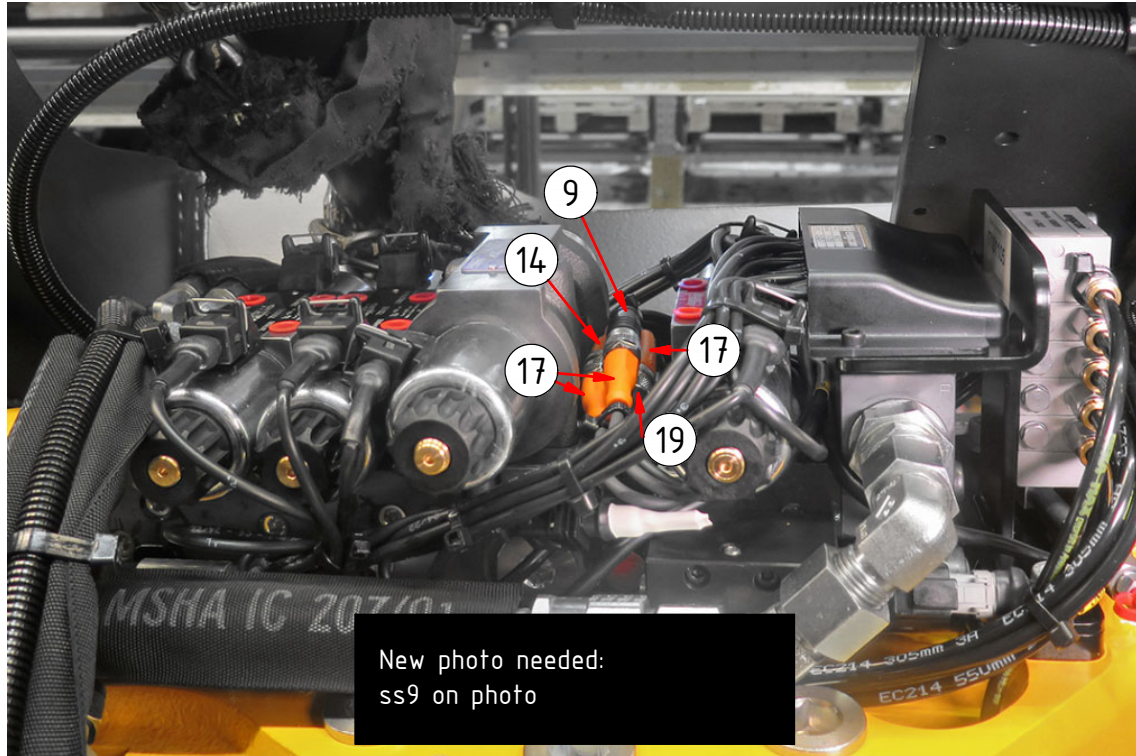

POS	DESCRIPTION	PART	QTY	COMMENTS
9	Rotation sensor	8001543	1	White side towards magnet
10	Tilt angle sensor	8001544	1	White side towards magnet
14	Adapter cable tilt sensor 1200mm	8001611	1	For EC214-EC233
17	Y-split M12 EVC614	1069559	1	
19	Ad.cable ss9/SVAB ECOW 120 ohm	8000825	1	
20	Ad.cable ss9/SVAB w. 120 ohm ter.	8000824	1	
25	Rubber steel clamp ø14	613009	*	
●	Use cable ties			

ss9/ss10 (SVAB) without EC-Oil:

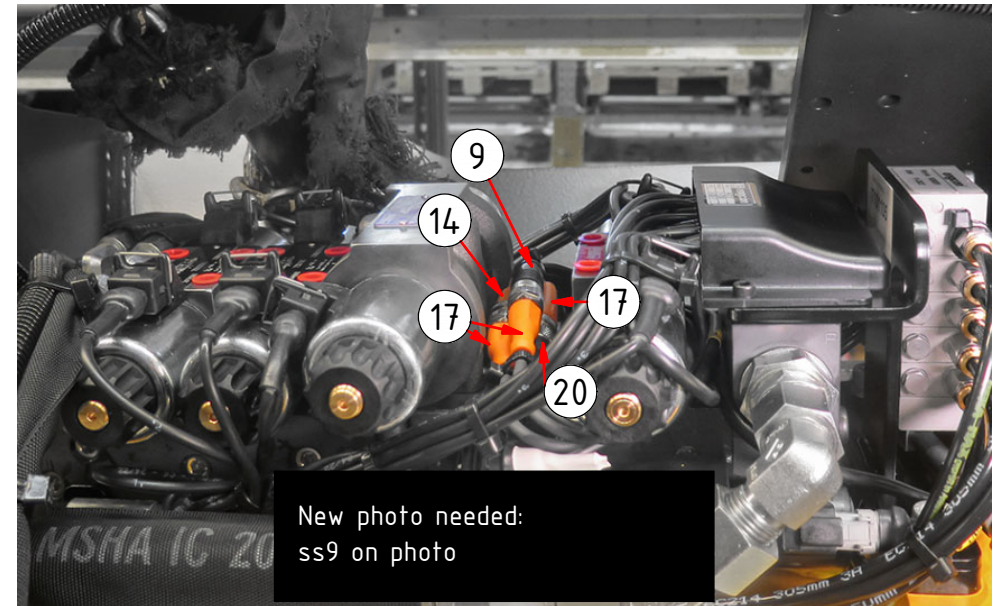

EC214:

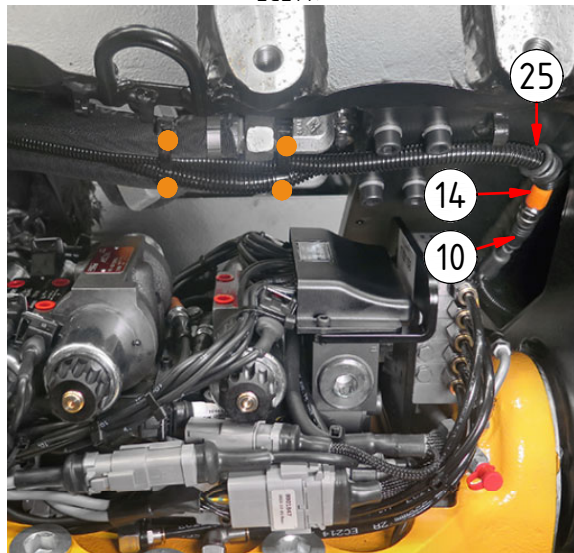

EC219:

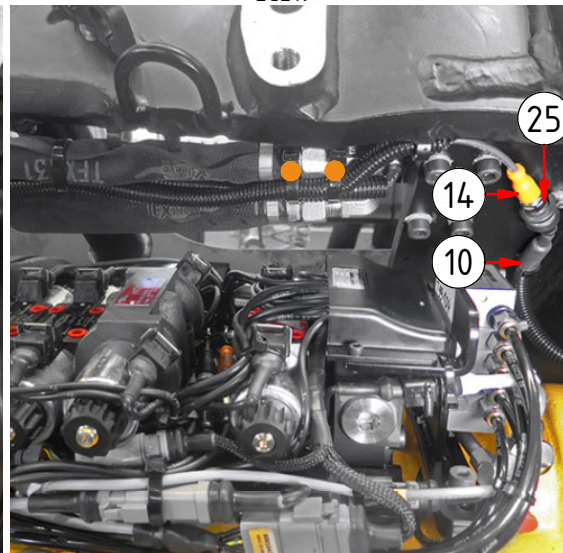

EC214:

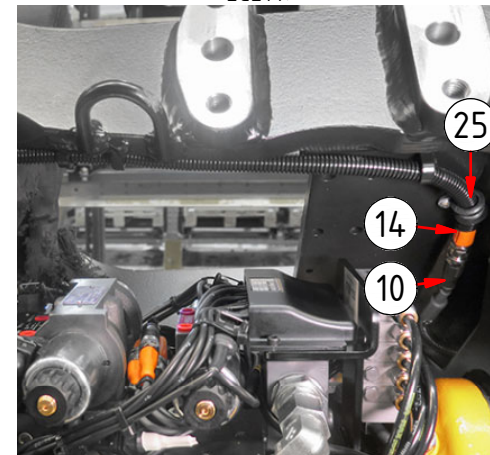

EC219:

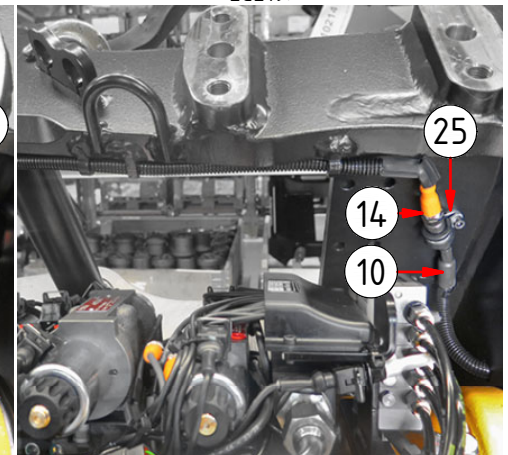

EC226-EC233
DC2 EC-Oil

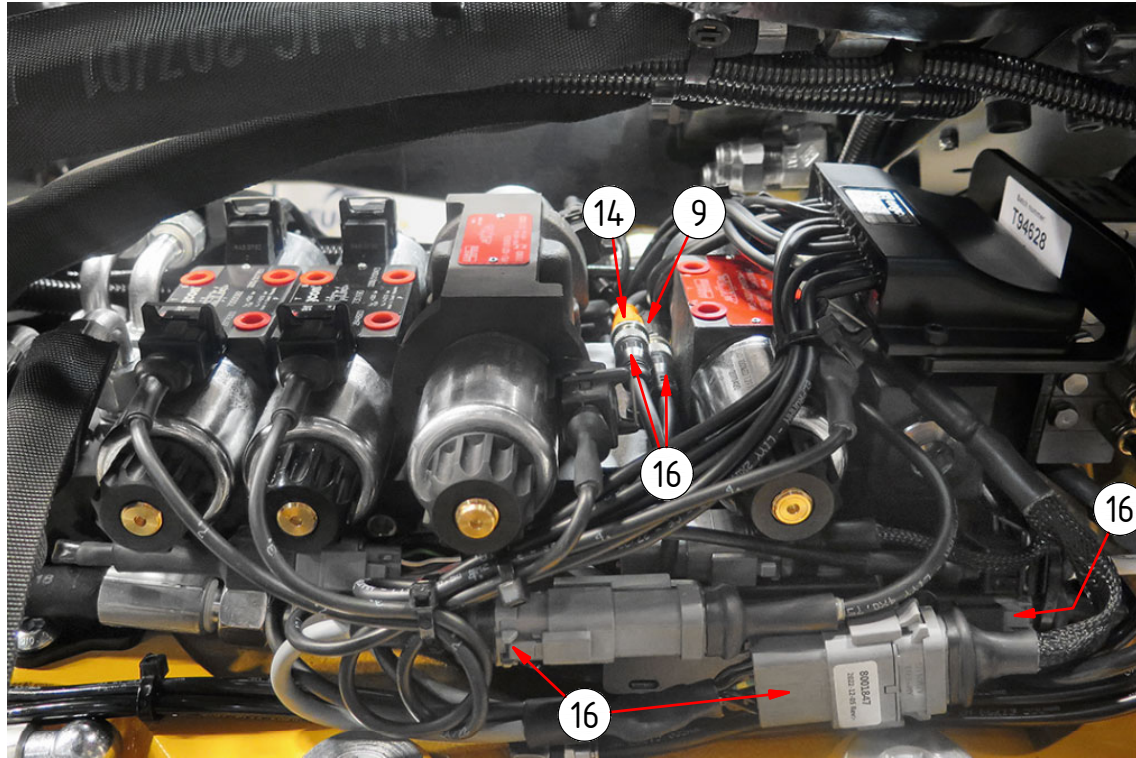

POS	DESCRIPTION	PART	QTY	COMMENTS
9	Rotation sensor	8001543	1	White side towards magnet
10	Tilt angle sensor	8001544	1	White side towards magnet
14	Adapter cable tilt sensor 1200mm	8001611	1	For EC214-EC233
16	Adapter cable ECO W DC2 ePS2	8001847	1	Part of Control system
17	Y-split M12 EVC614	1069559	1	
18	Adapter cable DC2	8000783	1	
25	Rubber steel clamp $\varnothing 14$	613009	*	
●	Use cable ties			

POS in order of assembly

DC2 without EC-Oil:

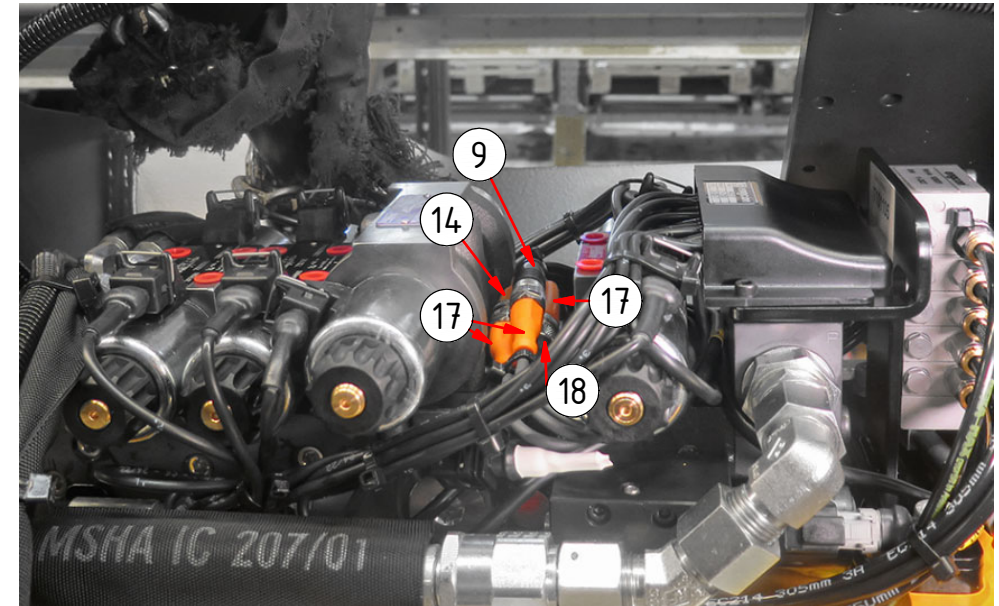

EC226:

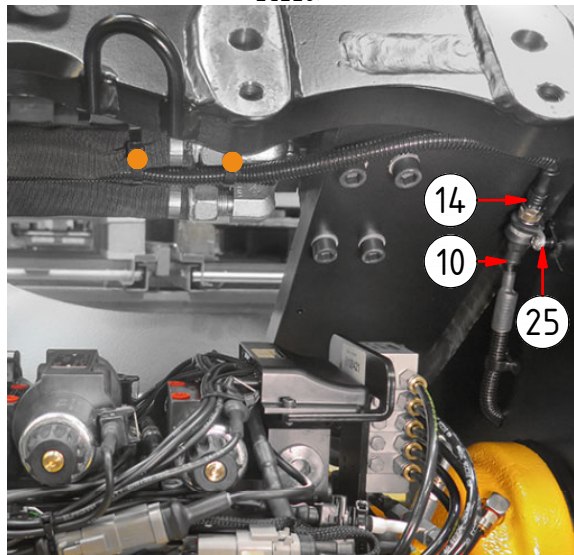

EC233:

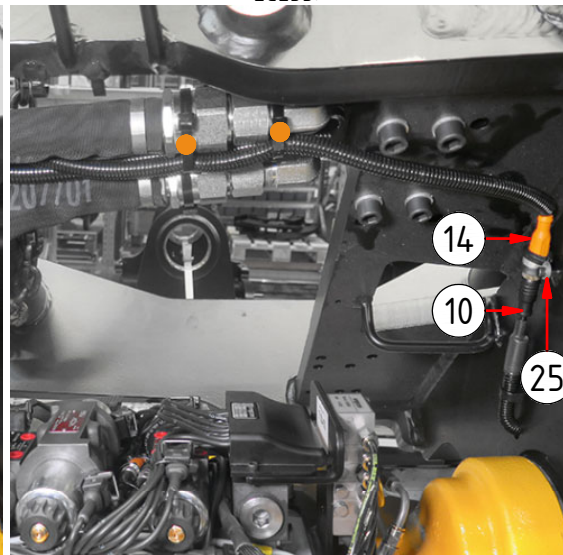

EC226-EC233

ss9/ss10 (SVAB) EC-Oil

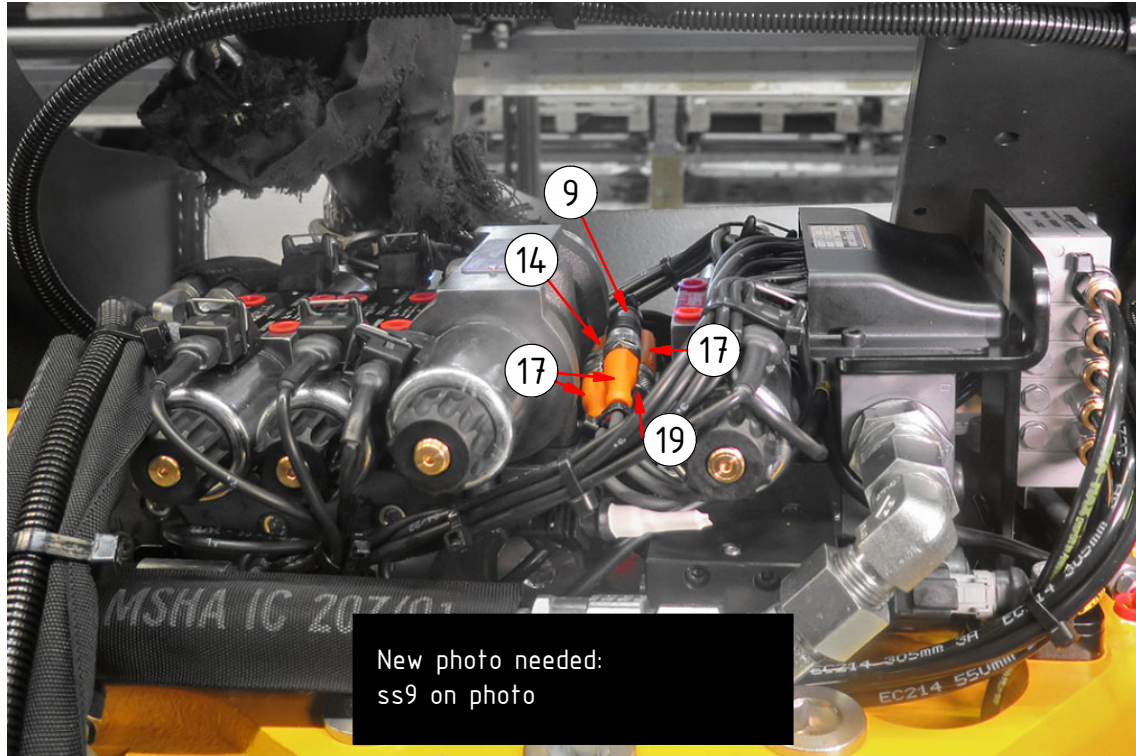

POS	DESCRIPTION	PART	QTY	COMMENTS
9	Rotation sensor	8001543	1	White side towards magnet
10	Tilt angle sensor	8001544	1	White side towards magnet
14	Adapter cable tilt sensor 1200mm	8001611	1	For EC214-EC233
17	Y-split M12 EVC614	1069559	1	
19	Ad.cable ss9/SVAB ECOW 120 ohm	8000825	1	
20	Ad.cable ss9/SVAB w. 120 ohm ter.	8000824	1	
25	Rubber steel clamp ø14	613009	*	
●	Use cable ties			

ss9/ss10 (SVAB) without EC-Oil:

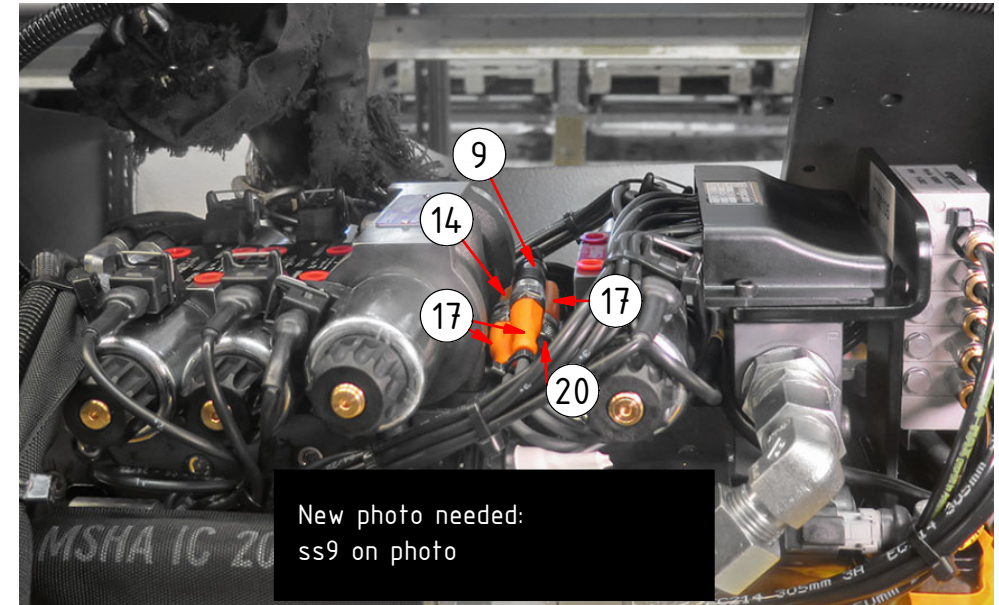

EC226:

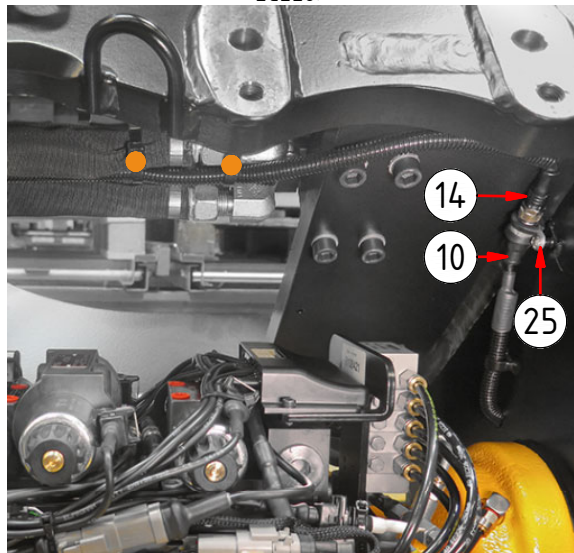

EC233:

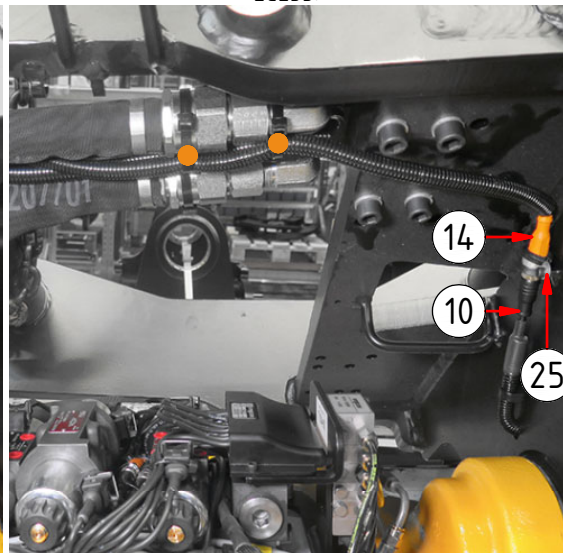

RELATED SPARE PARTS

POS	DESCRIPTION	PART	QTY	COMMENTS
13	Adapter cable tilt sensor 600mm	8001610	1	For EC206B-EC209B
14	Adapter cable tilt sensor 1200mm	8001611	1	For EC214-EC233
17	Y-split M12 EVC614	1069559	1	
18	Adapter cable DC2	8000783	1	
20	Ad.cable ss9/SVAB w. 120 ohm ter.	8000824	1	
24	Screw K6S M5x8 10.9 FZB	611801	*	
25	Rubber steel clamp $\varnothing 14$	613009	*	
27	Y-split M12 EBC116	1065340	1	Replaced by POS.17

POS in order of assembly

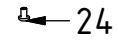

DC2 with Y-split "EBC116":

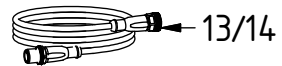

ss9/ss10 (SVAB) with Y-split "EBC116":

