

COVERSHEET

Planned document changes:

Briefly:

2026-06-23. Correct description POS.9: Banjo bolt 4451-02 (1/8").

Document changes:

Date:	Change:	Rev. after change:
2024-08-29	Missing washer added.	C
2024-04-10	Adapters against cyl. added.	B
2023-09-21	Grab Open/Close corrected.	A
2023-03-21	New document.	-

Readers note:

 Indicates instruction.

 Represents Hose.

Dashed lines for overview, mounts
on other pages/assemblies.

EC204 - Hitch CW05GP GR05

POS	DESCRIPTION	PART	QTY	COMMENTS
1	Quick hitch CW05GP 0° GR05 Compl.	1069936	1	
2	Feather Key	650101	6	
3	Screw MC6S M12x80 12.9 ZFSL	6000148	12	Torque: 136Nm

POS in order of assembly

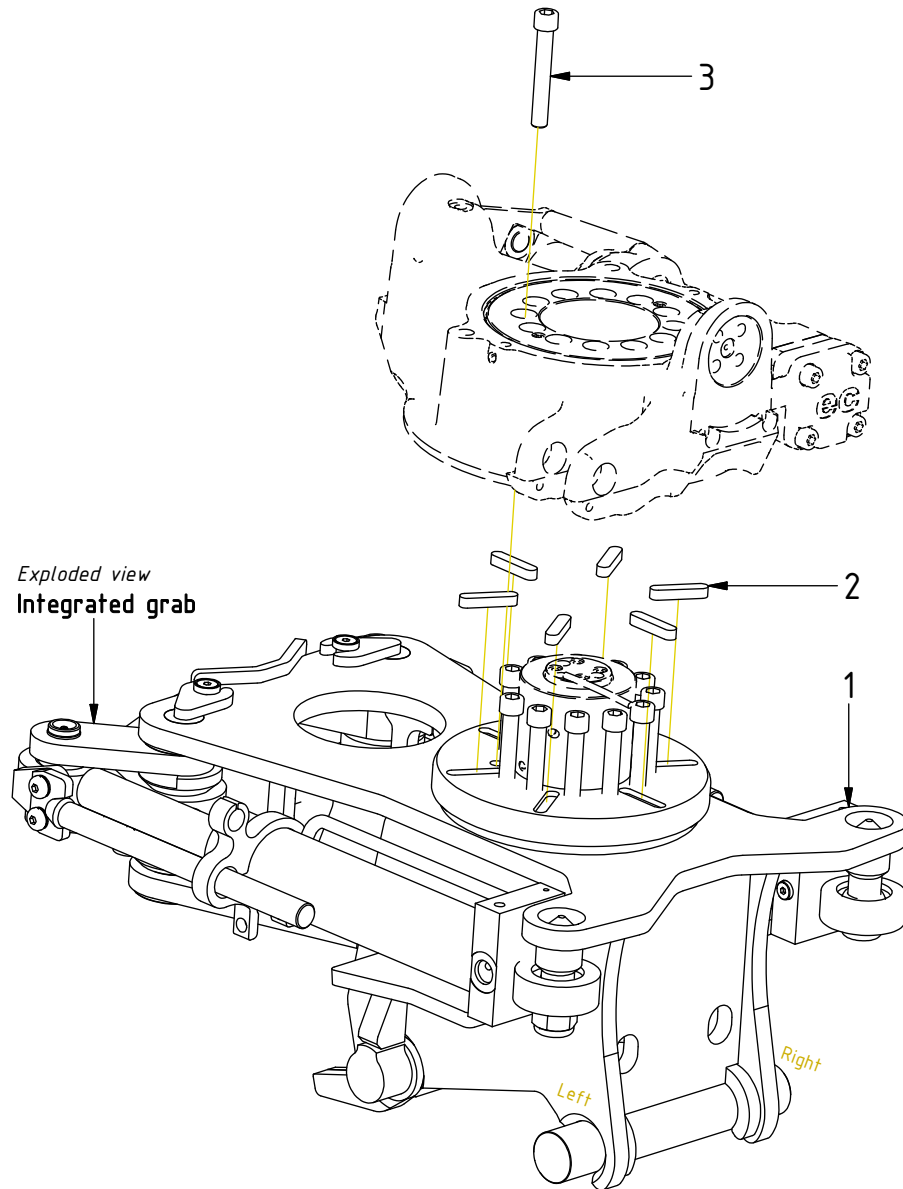

POS in order of assembly

POS	DESCRIPTION	PART	QTY	COMMENTS
4	Adapter 401-02-02 90° (1/8")	710293	1	
5	Washer GBR04 1/4	710702	10	QTY: 4 part of Integrated grab
6	Adapter 136-04-04 (1/4")	7000531	2	
7	Washer GBR02 1/8	710701	2	
8	Hose Lock Close	7001382	1	
9	Banjo bolt 4451-02 (1/2")	710277	1	
10	Hose Lock Open	7001381	1	
11	Hose Grab Internal	7000141	2	
12	Adapter 853-04-99 (1/4")	710184	2	
13	Hose Grab Long	7000112	2	
14	Hose Grab Short	7000113	2	
15	Quick Coupler 1/4" Male 2520	790111	2	
16	Quick coupler 1/4" 2510 cejn	790110	2	
17	Adapter 401-04-04 90° (1/4")	710151	1	
18	Adapter 45° 402-04-04(1/4")	7000104	1	
19	Adapter 138-04-29 (1/4")	710135	4	Part of Integrated grab

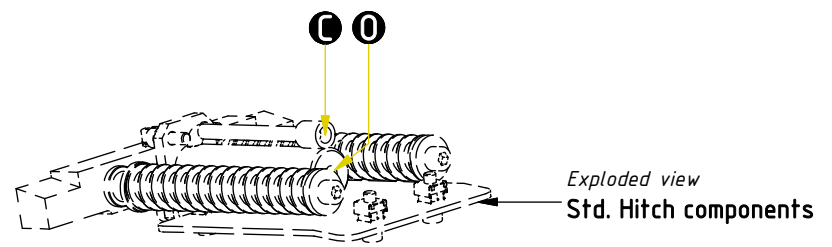
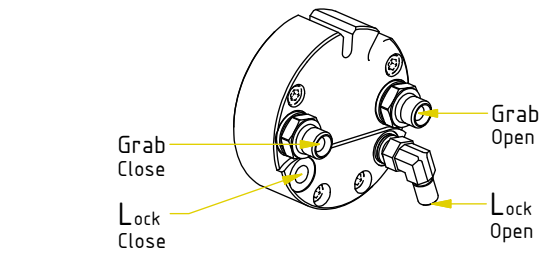
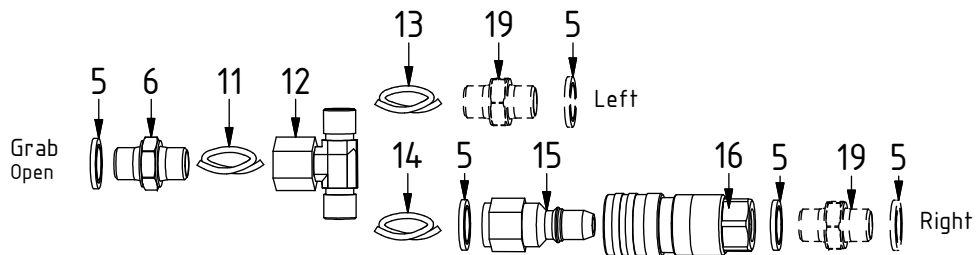
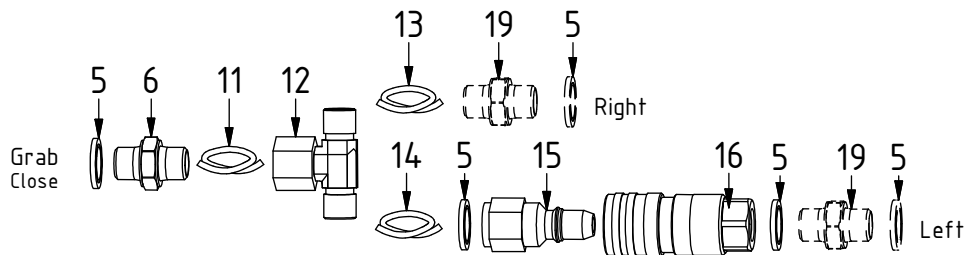
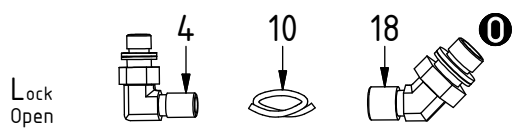
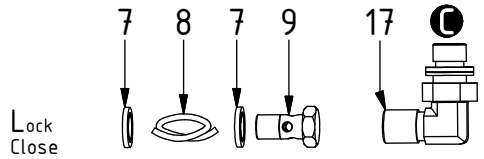

POS	DESCRIPTION	PART	QTY	COMMENTS
8	Hose Lock Close	7001382	1	
10	Hose Lock Open	7001381	1	
11	Hose Grab Internal	7000141	2	
13	Hose Grab Long	7000112	2	
14	Hose Grab Short	7000113	2	

