

## COVERSHEET

## Planned document changes:

**Briefly:**

2026-06-23. Correct description POS.11: Banjo bolt 4451-02 (1/8").

## Document changes:

Date:	Change:	Rev. after change:
2024-04-10	Adapters against cyl. added.	D
2022-12-22	Open/Close corrected.	C
2020-06-25	Part nos added.	B
2020-05-06	Adapters for Open and Extra A corrected.	A
2020-04-29	New document.	-

*Readers note:*

Indicates instruction.



Represents Hose.

Dashed lines for overview, mounts  
on other pages/assemblies.

POS	DESCRIPTION	PART	QTY	COMMENTS
1	Quick hitch CW05EC EC204	1042769	1	
2	Quick hitch CW05EC 0° EC204	1047483	1	
3	Quick hitch CW05EC 11° EC204	1048694	1	
4	Feather Key	650101	6	
5	Screw MC6S M12x80 12.9 ZFSHL	6000148	12	Torque: 136Nm

POS in order of assembly

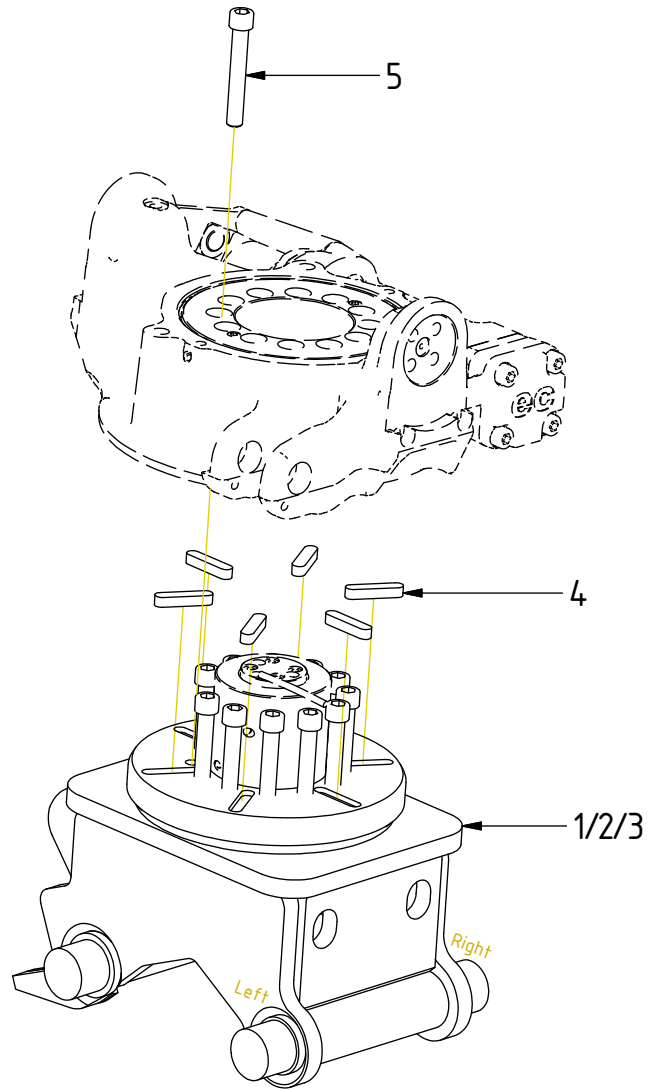

POS	DESCRIPTION	PART	QTY	COMMENTS
6	Adapter 401-02-02 90° (1/8")	710293	1	
7	Washer GBR04 1/4	710702	8	
8	Adapter 236-04-04	1013885	1	
9	Washer GBR02 1/8	710701	2	
10	Hose Lock Close	7001382	1	
11	Banjo bolt 4451-02 (1/2")	710277	1	
12	Hose Lock Open	7001381	1	
13	Hose Extra	7000111	2	
14	Banjo bolt 4451-04 (1/4")	710271	2	
15	Counternut 1270-04 (1/4")	710250	2	
16	Adapter 1260-04-04 (1/4")	710240	2	
17	Quick Coupler 1/4" Male 2520	790111	2	
18	Dust protection 1/4"	790119	2	
19	Adapter 401-04-04 90° (1/4")	710151	1	
20	Adapter 45° 402-04-04(1/4")	7000104	1	

POS in order of assembly

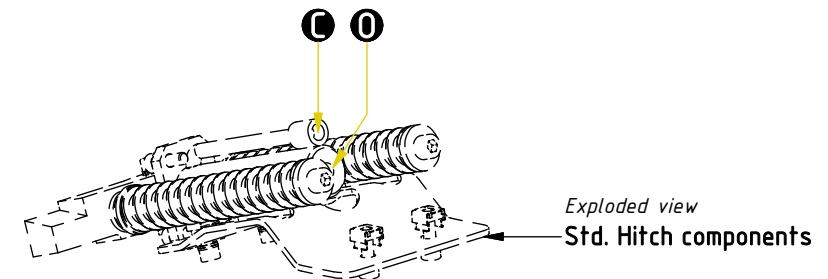
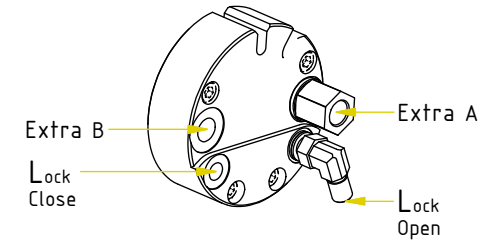
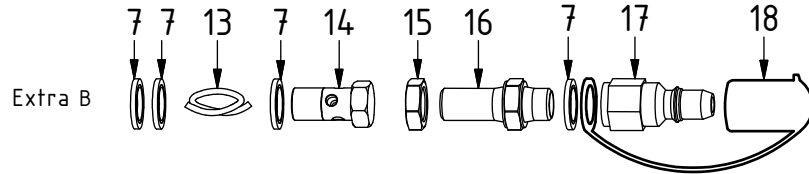
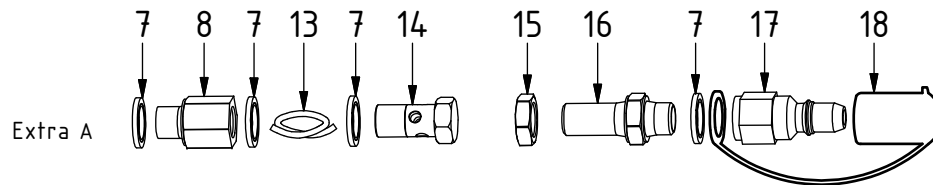
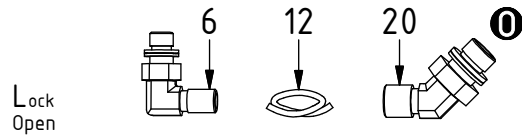
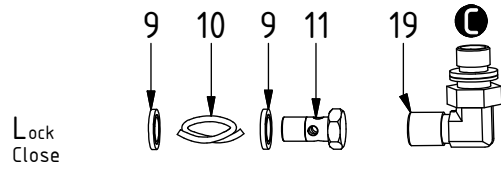

POS	DESCRIPTION	PART	QTY	COMMENTS
10	Hose Lock Close	7001382	1	
12	Hose Lock Open	7001381	1	
13	Hose Extra	7000111	2	

