

Planned document changes:

Briefly:

No planned changes.

Document changes:

Date:	Change:	Rev. after change:
2024-03-01	Expander axle for Links corrected.	A
2024-01-31	New document.	-

Readers note:

Indicates instruction.



Represents Hose.

Dashed lines for overview, mounts
on other pages/assemblies.

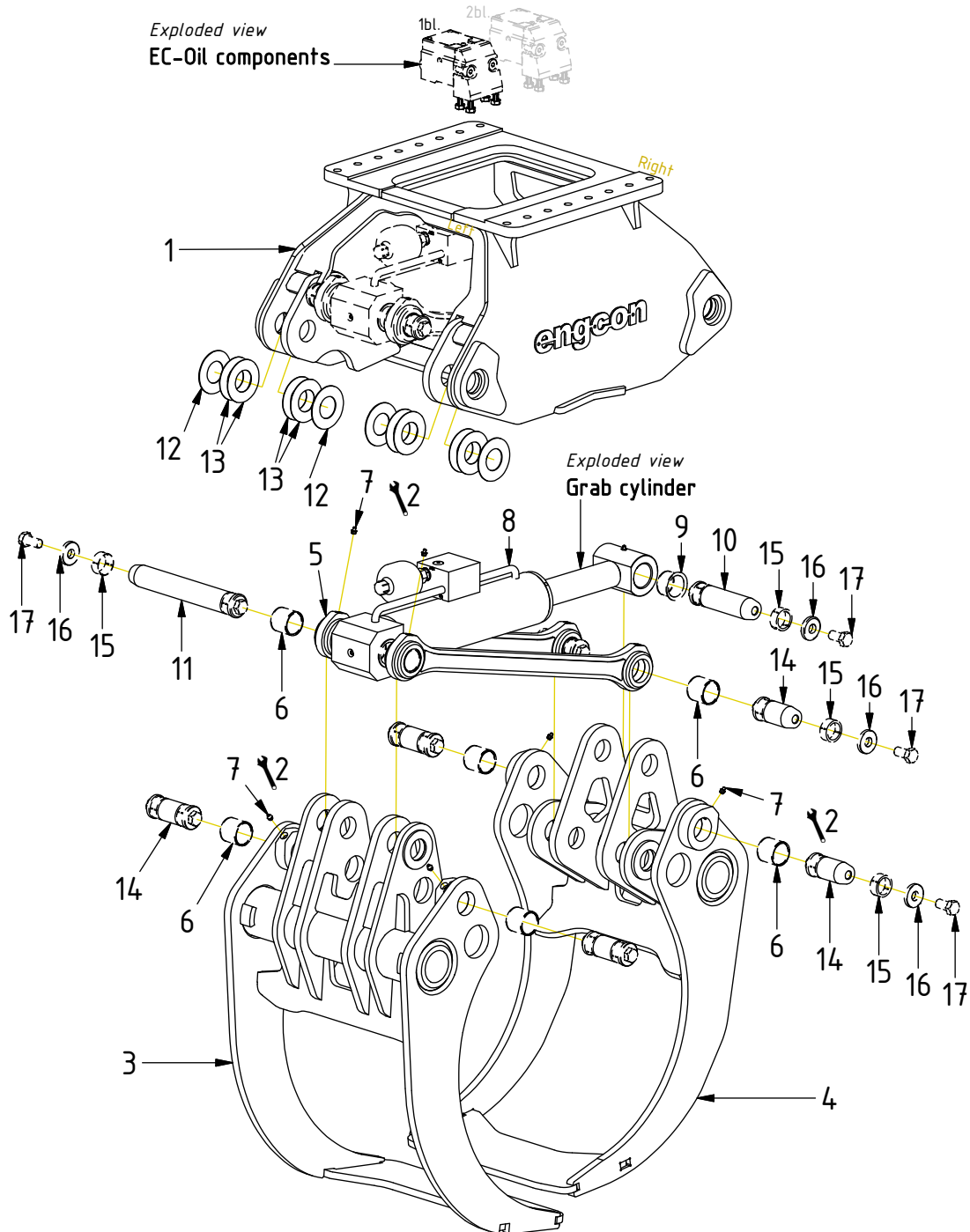

POS	DESCRIPTION	PART	QTY	COMMENTS
1	Main frame TG42HD V2	1072408	1	
2	Fill lubrication points with grease			
3	Arm wide TG42 V2	1072484	1	(POS.6-7 incl.)
4	Arm narrow TG42 V2	1072610	1	(POS.6-7 incl.)
5	Link TG42HD V2	1072972	2	(POS.6-7 incl.)
6	Bushing WB802 50/55x50	630308	8	
7	Grease nippel H1 M10x1	790166	2	
8	Cylinder TG42HD V2	1072509	1	
9	Bushing 50/55/65x37,5	630403	4	
10	Expander axle TG42 L=170mm	1034856	1	(POS.15-17 incl.)
11	Expander axle TG42 L=318mm	1034854	1	(POS.15-17 incl.)
12	Shim 100/51x2	1024935	8	Use if required
13	Shim 100/51x1.0	1024934	16	Use if required
14	Expander axle TG42 L=98mm	1034844	6	(POS.15-17 incl.)
15	Sleeve	1034846	16	
16	Washer	1034855	16	
17	Bolt M20x1.5 L=40mm 12.9 DIN 933	1034847	16	Torque: 350Nm

POS	DESCRIPTION	PART	QTY	COMMENTS
18	Washer GBR08 1/2	710704	4	QTY: 6 for ECO60
19	Adapter 135-06-08	710122	4	QTY: 2 for ECO60
20	Hose Cylinder	740910	2	
21	Quick coupler 1/2" female	790114	2	
22	Dust protection 1/2" female	790118	2	
23	Hose EC-Oil	740702	2	
24	Banjo bolt 4451-08 (1/2")	710274	2	
25	Adapter 135-06-12 (3/8"-3/4")	710107	2	
26	Washer GBR12 3/4	710706	2	

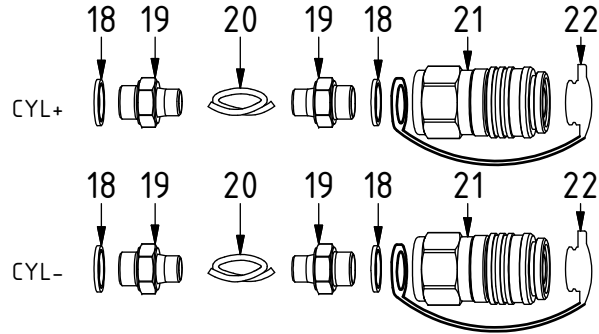

ECO60 W:

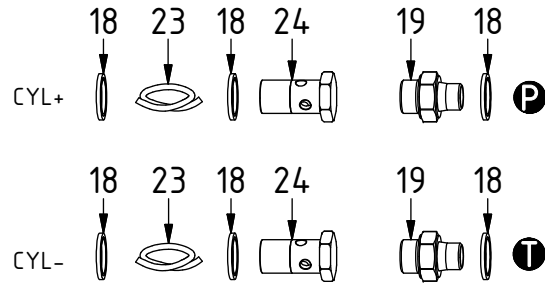

ECO70 W:

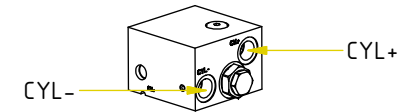
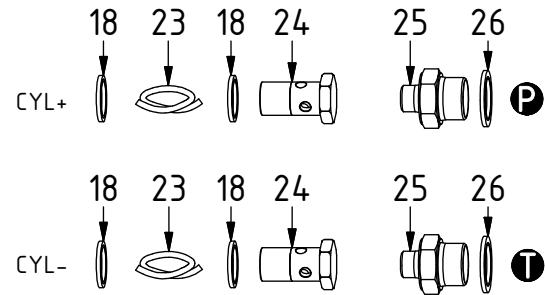

EC-Oil:

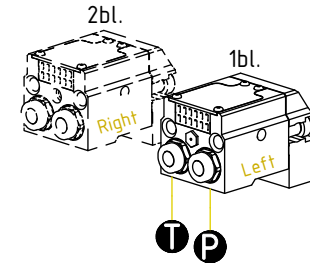

ECO w:

POS	DESCRIPTION	PART	QTY	COMMENTS
20	Hose Cylinder	740910	2	
23	Hose EC-Oil	740702	2	

POS in order of assembly

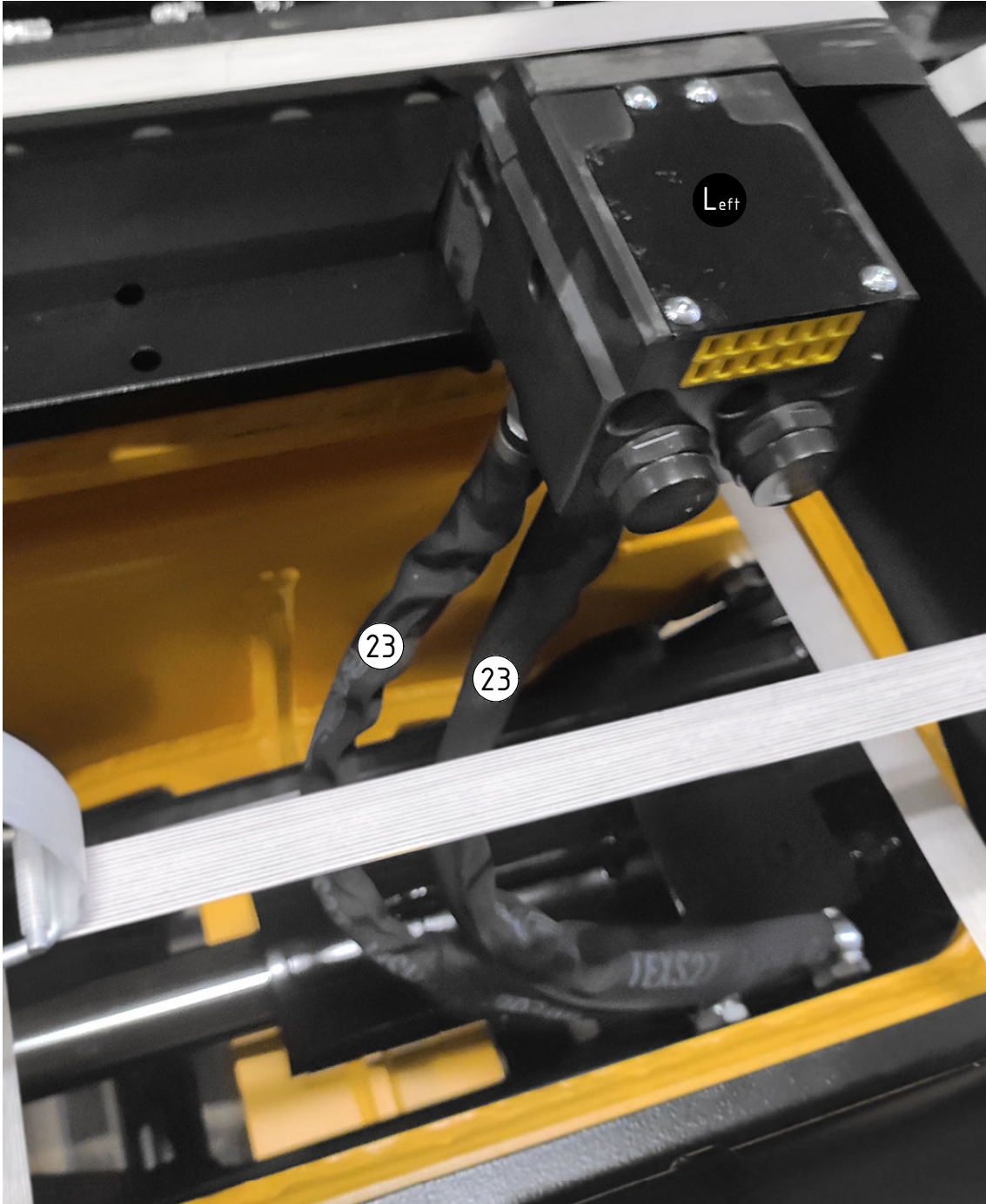

Without ECO:

