

COVERSHEET

Planned document changes:

Briefly:

No planned changes.

Document changes:

Date:	Change:	Rev. after change:
2024-01-05	Protective covers updated.	A
2023-12-14	New document.	-

Readers note:

 Indicates instruction.

 Represents Hose.

Dashed lines for overview, mounts
on other pages/assemblies.

POS	DESCRIPTION	PART	QTY	COMMENTS
1	Connection block P reducer Compl.	1027363	1	(POS.2-3 incl.)
2	Pressure reduction valve VRN2-10	730326	1	
3	Plug 3/4"	711532	3	Torque: 120Nm
4	O-ring 15,54x2,62	712423	2	
5	Washer NL 10mm	611041	8	QTY: 4 part of make up
6	Screw MC6S M10x45 12.9	610589	4	
7	Washer GBR06 3/8	710703	4	
8	Adapter 136-06-06 (3/8")	710106	4	
15	Protective cover EC219 Right	1027796	1	Part of make up
16	Protective cover EC219 Left	1027795	1	Part of make up
17	Screw M6S M10x25 8,8 FZB	610142	4	Part of make up

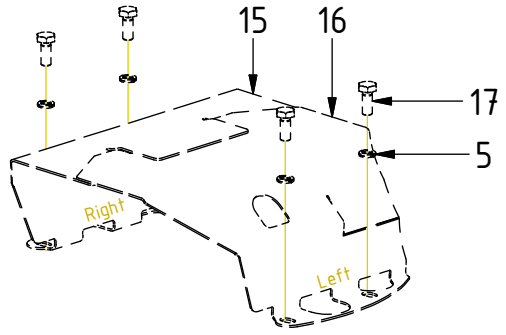

Exploded view
Std. Valves & cables

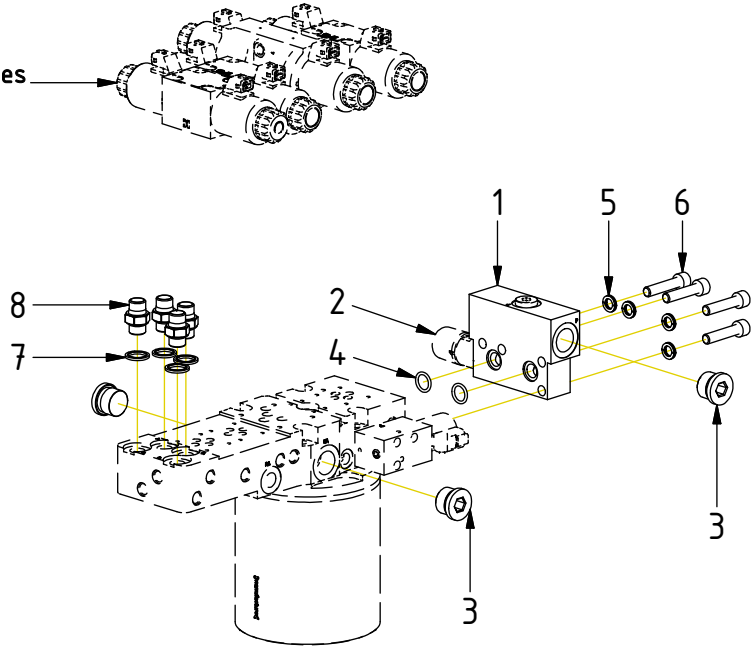

Hoses EC-Oil

POS	DESCRIPTION	PART	QTY	COMMENTS
7	Washer GBR06 3/8	710703	4	
8	Adapter 136-06-06 (3/8")	710106	4	
9	Washer GBR12 3/4	710706	2	
10	Adapter 135-08-12 (1/2"-3/4")	710109	2	
11	Adapter 488-08-08 90° (1/2")	712209	2	
12	Hose Feed EC-Oil P	7001637	1	
13	Hose Feed EC-Oil T	7001638	1	
14	Hose Tilt	7000027	4	

POS in order of assembly

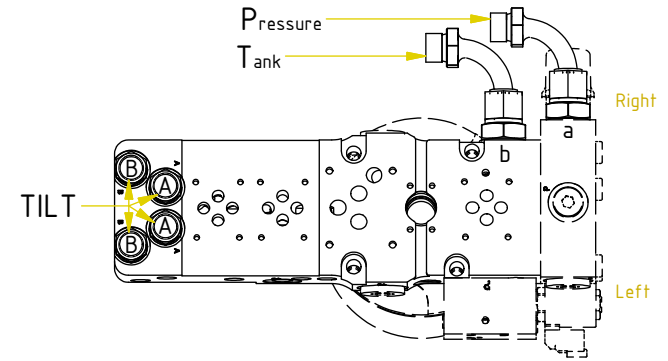
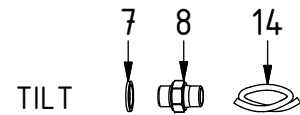
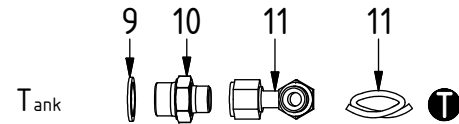
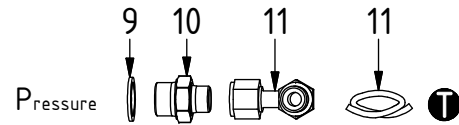

Hoses
EC-Oil

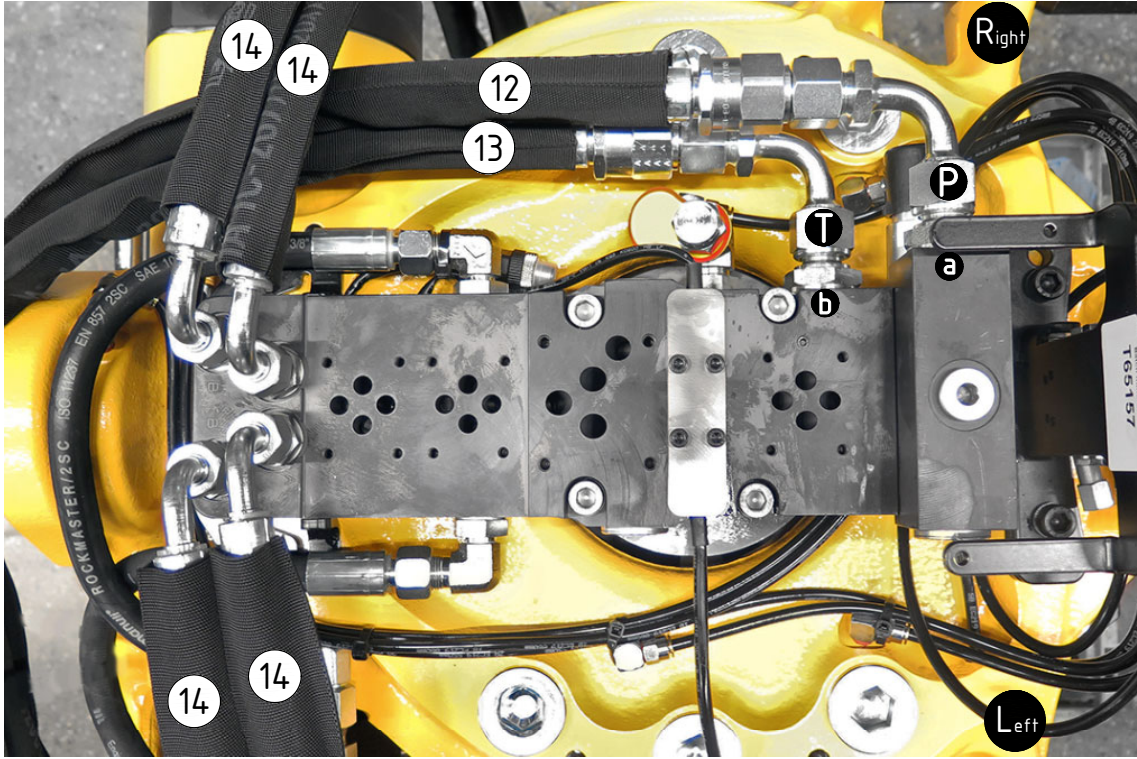

POS	DESCRIPTION	PART	QTY	COMMENTS
12	Hose Feed EC-Oil P	7001637	1	
13	Hose Feed EC-Oil T	7001638	1	
14	Hose Tilt	7000027	4	

POS in order of assembly