

COVERSHEET

Planned document changes:

Briefly:

2024-04-08. Part no for POS.17: 7000104. Part no for POS.4 against cyl: 710151.

Document changes:

Date:	Change:	Rev. after change:
2023-03-17	New document.	-

Readers note:

 Indicates instruction.

 Represents Hose.

Dashed lines for overview, mounts
on other pages/assemblies.

POS	DESCRIPTION	PART	QTY	COMMENTS
1	Quick hitch CW05GP 0° EC204	1065318	1	
2	Feather Key	650101	6	
3	Screw MC6S M12x80 12.9 ZFSL	6000148	12	Torque: 136Nm

POS in order of assembly

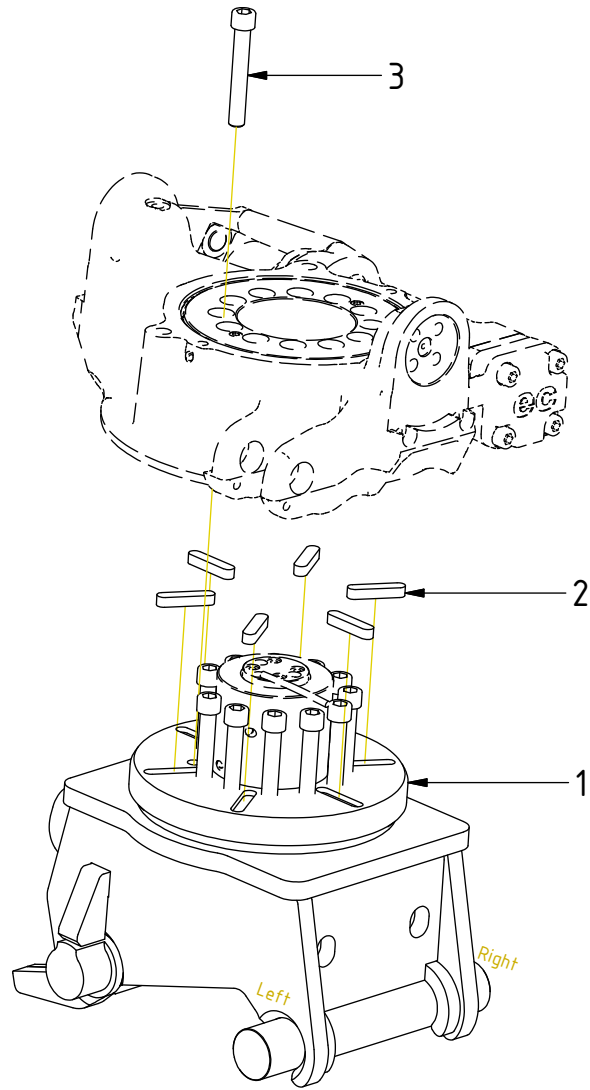

POS	DESCRIPTION	PART	QTY	COMMENTS
4	Adapter 401-02-02 90° (1/8")	710293	2	
5	Washer GBR04 1/4	710702	8	
6	Adapter 236-04-04	1013885	1	
7	Washer GBR02 1/8	710701	2	
8	Hose Lock Close	7001382	1	
9	Banjo bolt 4451-02 (1/2")	710277	1	
10	Hose Lock Open	7001381	1	
11	Hose Extra	7000111	2	
12	Banjo bolt 4451-04 (1/4")	710271	2	
13	Counternut 1270-04 (1/4")	710250	2	
14	Adapter 1260-04-04 (1/4")	710240	2	
15	Quick Coupler 1/4" Male 2520	790111	2	
16	Dust protection 1/4"	790119	2	
17	Adapter 45° 402-02-02 (1/8")		1	

POS in order of assembly

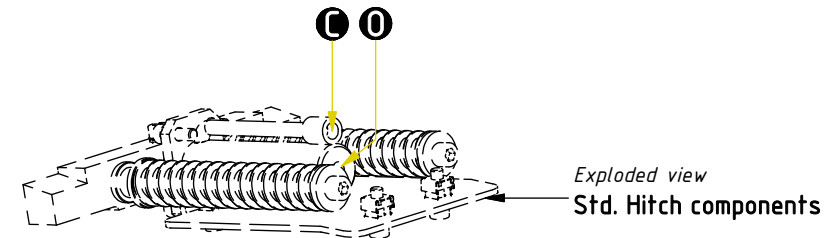
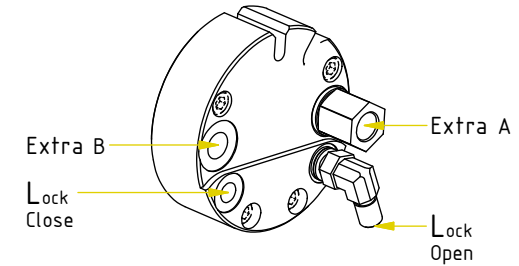
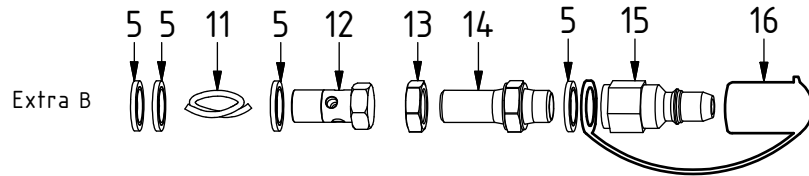
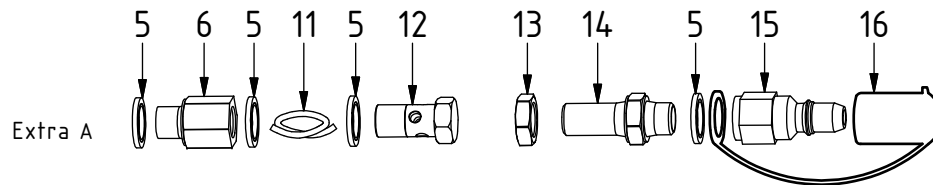
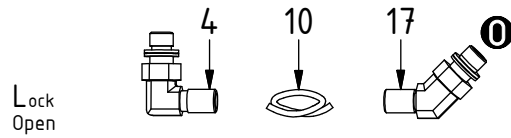
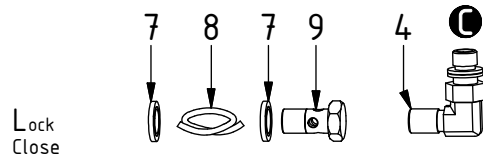

POS	DESCRIPTION	PART	QTY	COMMENTS
8	Hose Lock Close	7001382	1	
10	Hose Lock Open	7001381	1	
11	Hose Extra	7000111	2	

