

COVERSHEET

Planned document changes:

Briefly:

No planned changes.

Document changes:

Date:	Change:	Rev. after change:
2024-08-13	Drain ECO part no corrected.	E
2024-03-15	Hose for option Drain ECO added.	D
2023-08-10	Spare parts updated.	C
2023-03-23	O-rings corrected. New ECO adapter cable added.	B
2022-11-24	Spare parts added.	A
2022-08-30	New document.	-

Readers note:

 Indicates instruction.

 Represents Hose.

Dashed lines for overview, mounts
on other pages/assemblies.

POS in order of assembly

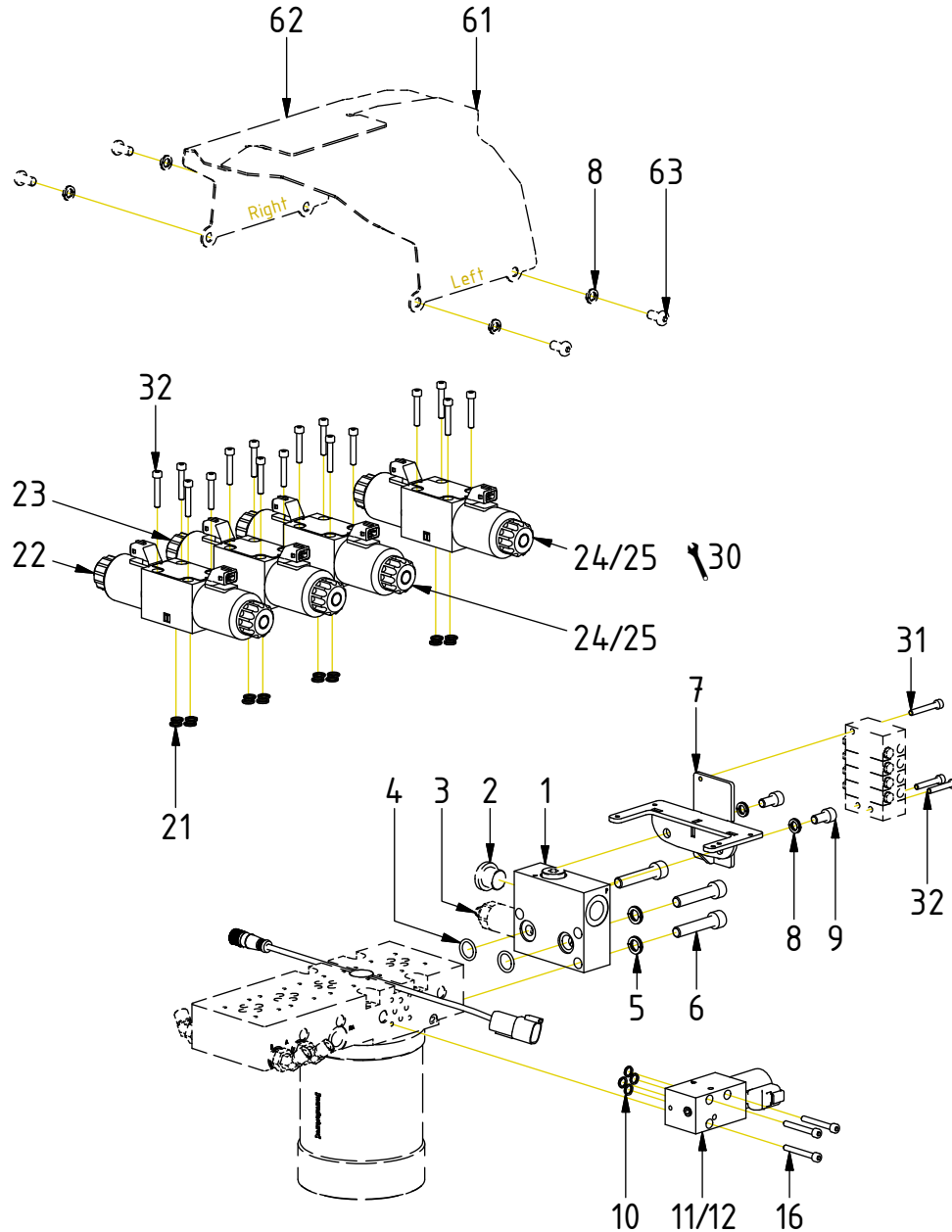

POS	DESCRIPTION	PART	QTY	COMMENTS
1	Connection block P reducer Compl.	1055945	1	(POS.2-3 incl.)
2	Plug VSTIR12ED	711500	1	Opposite side for EC-Oil
3	Pressure reduction valve SP4A-B3	730288	1	
4	O-ring 15,54x2,62	712423	2	
5	Washer NL 10mm	611041	3	
6	MC6S M10x50 12.9 ZFSHL	611515	3	
7	Mounting plate Central lub. QSM	1055574	1	
8	Washer NL 8mm	611040	6	QTY: 4 part of make up
9	Screw MC6S M8x16 12.9	610431	2	
10	O-ring 7,65x1,78	710960	4	
11	Directional valve NG4 IQS 12V DT	1042047	1	(POS.10, 13, 15 incl.)
12	Directional valve NG4 IQS 24V DT	1042190	1	(POS.10, 14, 15 incl.)
13	Coil IQS 12V DT	1042065	1	
14	Coil IQS 24V DT	1042066	1	
15	Nut 1270-04	710250	1	
16	Screw MC6S M5x40 12.9	610405	3	Torque: 9,7Nm. QTY: 1 when EC-Oil
17	Valve spacer M5x39	1047243	2	Torque: 9,7Nm
18	Mounting plate-1x Deutsch NG4	1058235	1	
19	Washer NL 5mm	611038	2	
20	Screw K6S M5x16 10.9 FZB	611818	2	Torque: 8,1Nm
21	O-ring 8,75x1,78	710959	16	
22	Directional valve prop 12V open T	7001615	1	(POS.21, 26, 29 incl.)
23	Directional valve prop 12V	7001614	1	(POS.21, 26, 29 incl.)
24	Directional valve NG6 12V	7001617	2	(POS.21, 27, 29 incl.)
25	Directional valve NG6 24V	7001616	2	(POS.21, 28, 29 incl.)
26	Coil NG6 12V prop JT ATOS	7001734	4	
27	Coil NG6 12V JT ATOS	7001735	4	
28	Coil NG6 24V JT ATOS	7001736	4	
29	Nut directional valve ATOS	7001887	8	
30	For option PROP on grab/extra			Use POS.23 instead of POS.24/25
31	Screw MC6S M5x35 12.9	610404	1	
32	Screw MC6S M5x30 12.9	610403	18	Torque: 9,7Nm
61	Protective cover EC209 QSM Left	1056632	1	Part of make up
62	Protective cover EC209 QSM Right	1056633	1	Part of make up
63	Screw K6S M8x16 10.9 FZB	611810	4	Part of make up

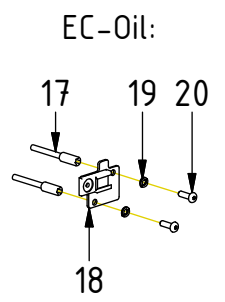

Hoses

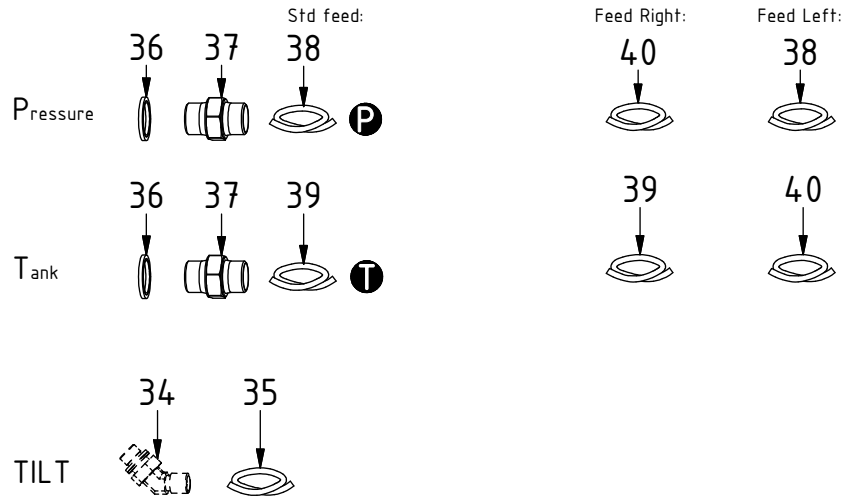

POS	DESCRIPTION	PART	QTY	COMMENTS
33	For option Drain			See p.8 for instruction
34	Adapter 45° 402-04-04(1/4")	7000104	4	Part of quick hitch assy.
35	Hose Tilt	7001308	4	
36	Washer GBR08 1/2	710704	3	
37	Adapter 136-08-08 (1/2")	710108	2	
38	Hose Feed P	7001265	1	
39	Hose Feed T	7001266	1	
40	Hose Feed Right/Left	7001586	1	Feed Right: Use this for "P" Feed Left: Use this for "T"
41	Adapter 235-08-06	7000705	1	
42	Washer GBR06 3/8	710703	1	
43	Adapter 136-06-06 (3/8")	710106	1	
44	Adapter 135-06-08	710122	1	
45	Hose Feed EC-Oil P	7001267	1	
46	Hose Feed EC-Oil T	7001268	1	

EC-Oil:

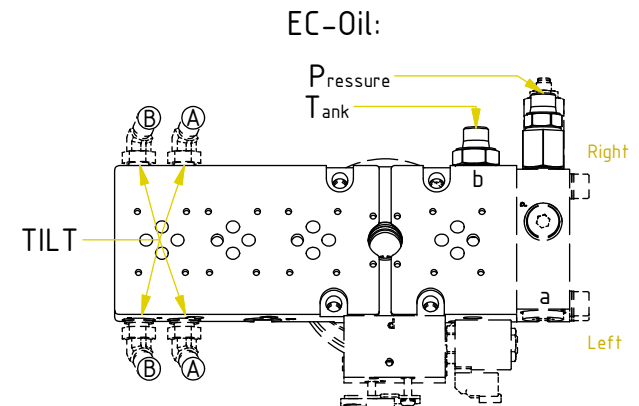
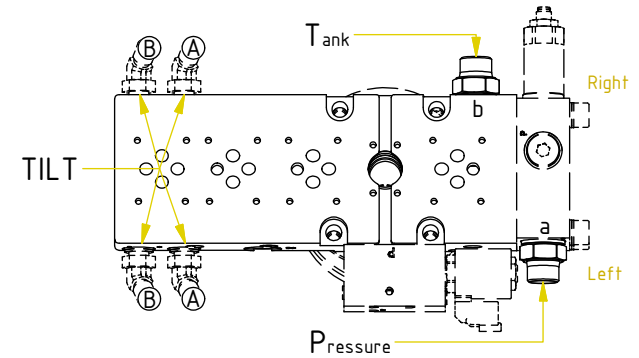
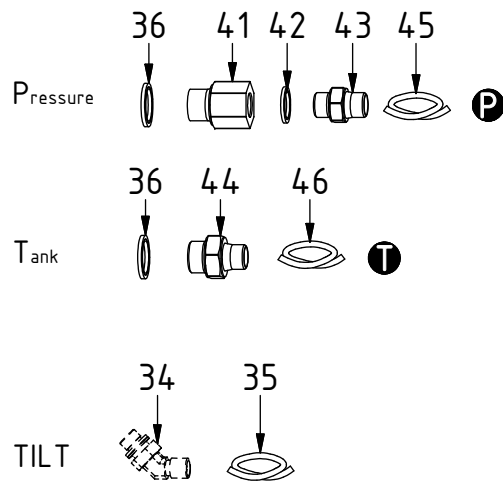

POS in order of assembly

EC209B - ss10 (DC2/SVAB)

Cables

POS	DESCRIPTION	PART	QTY	COMMENTS
50	Q-Safe connector			
51	Tiltrotator module DC2 Q-Safe	842137	1	
52	Jumper JT QSC connected	1018662	1	Plug JT connector "1"
53	Screw MC6S M5x12 12.9	6000077	2	
54	Aggregate cable DC2 Compl. QSC DT	8001201	1	
55	ILME cover 12P contact with jumper	810208	1	(Incl. with agg.cable)
56	Adapter cable ECOW DC2 DTM	1048529	1	For EC-Oil. Instead of agg.cable
57	Adapter cable ECOW DC2 DTM 2xM12		1	For EC-Oil & ePS2 Sensors Instead of agg.cable
59	Protection plate End lock EC209B	1063372	1	
60	Screw MC6S M12x70 12.9 Geomet	611517	8	Torque: 136Nm

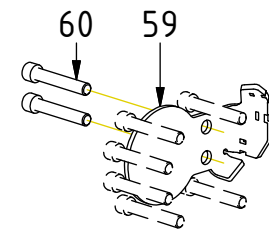
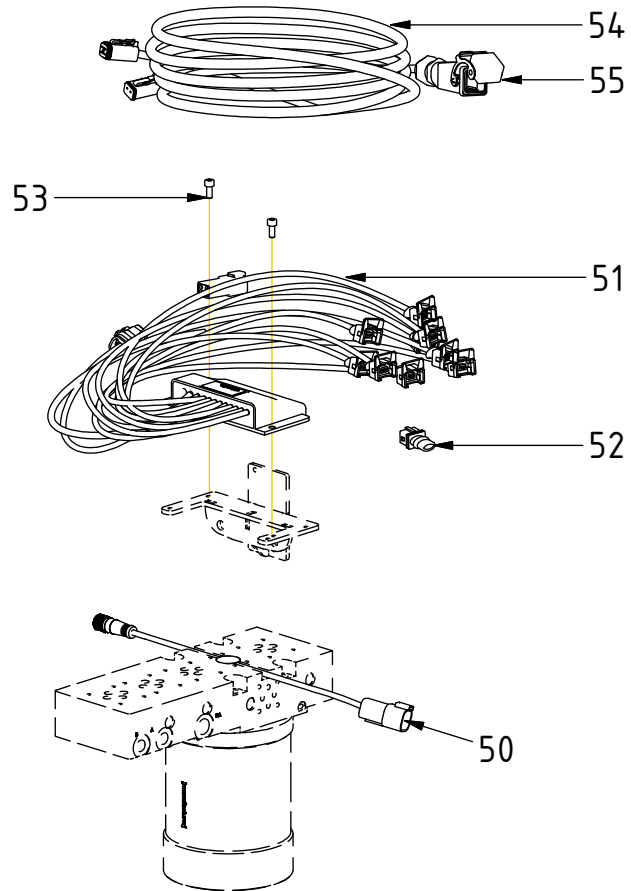

EC209BS:

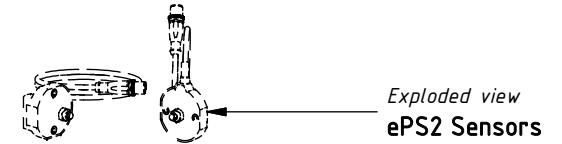

EC-Oil:

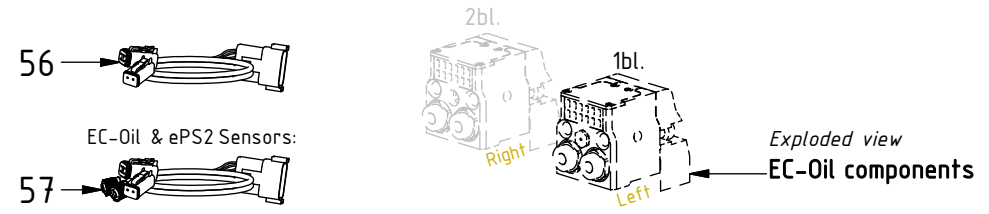

POS in order of assembly

Hoses
Std Feed

POS	DESCRIPTION	PART	QTY	COMMENTS
33	For option Drain			See p.8 for instruction
35	Hose Tilt	7001308	4	
38	Hose Feed P	7001265	1	
39	Hose Feed T	7001266	1	
40	Hose Feed Right/Left	7001586	1	Feed Right: Use this for "P" Feed Left: Use this for "T"
45	Hose Feed EC-Oil P	7001267	1	
46	Hose Feed EC-Oil T	7001268	1	

POS in order of assembly

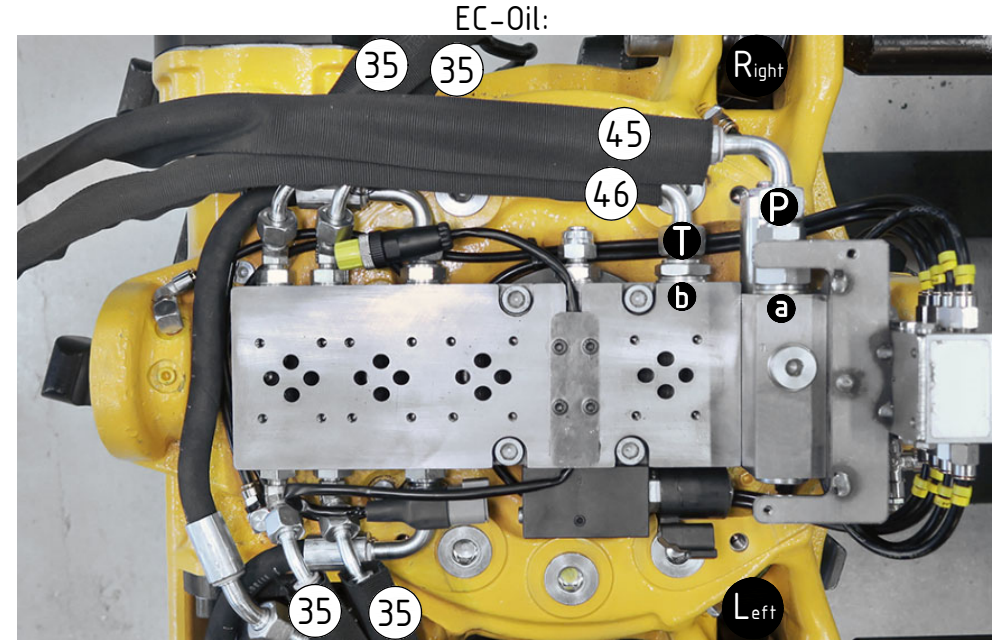
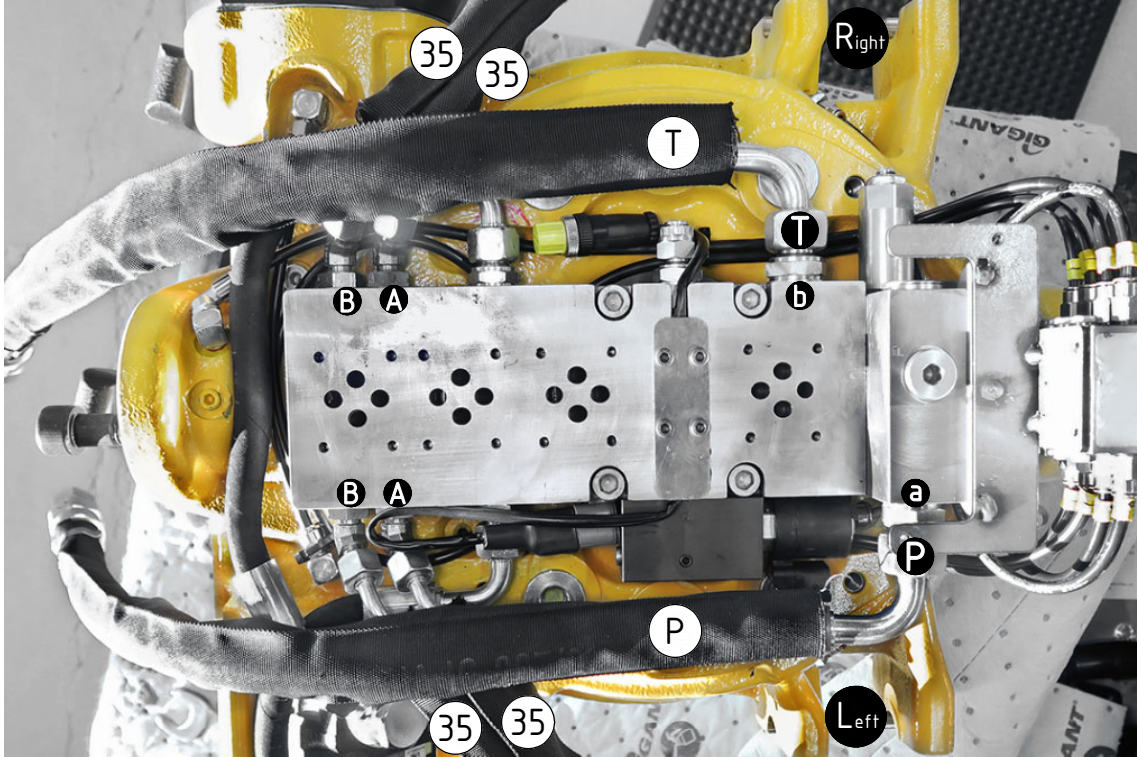

Cables

POS	DESCRIPTION	PART	QTY	COMMENTS
50	Q-Safe connector			
51	Tiltrotator module DC2 Q-Safe	842137	1	
52	Jumper JT QSC connected	1018662	1	Plug JT connector "1"
54	Aggregate cable DC2 Compl. QSC DT	8001201	1	
56	Adapter cable ECOW DC2 DTM	1048529	1	For EC-Oil. Instead of agg.cable
57	Adapter cable ECOW DC2 DTM 2xM12		1	For EC-Oil & ePS2 Sensors Instead of agg.cable
58	Protection plug DTM	8000090	1	
●	Use cable ties			

POS in order of assembly

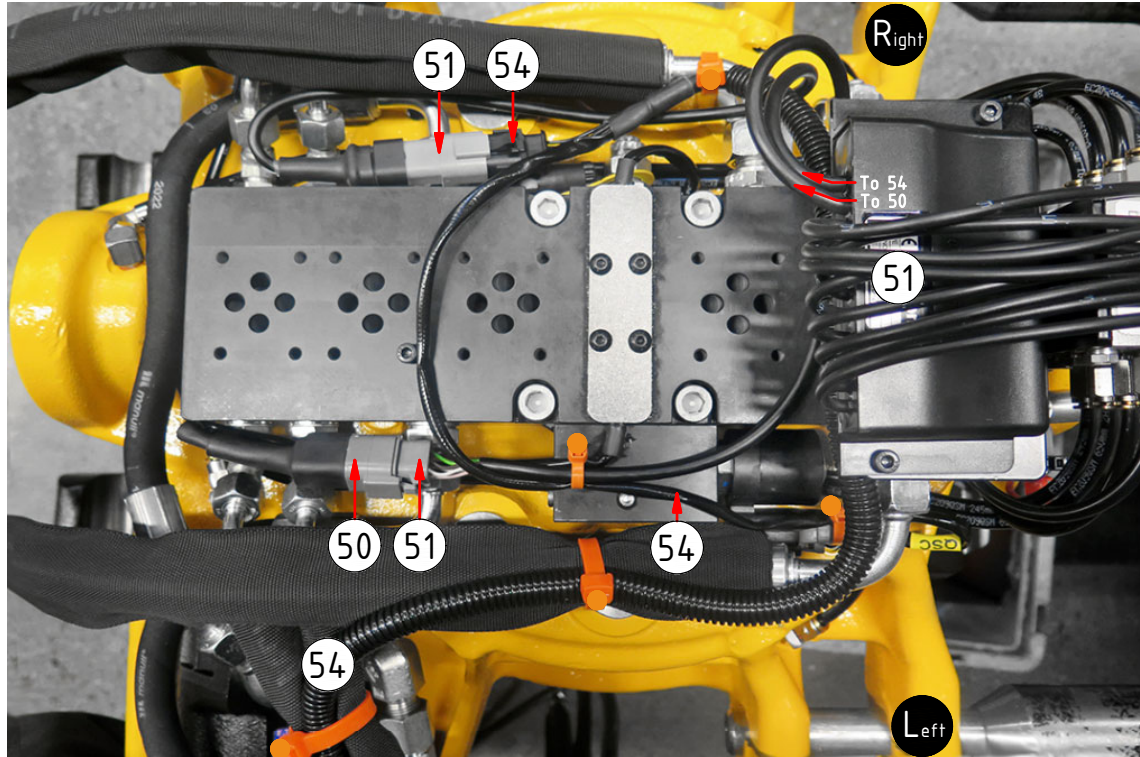

EC-Oil:

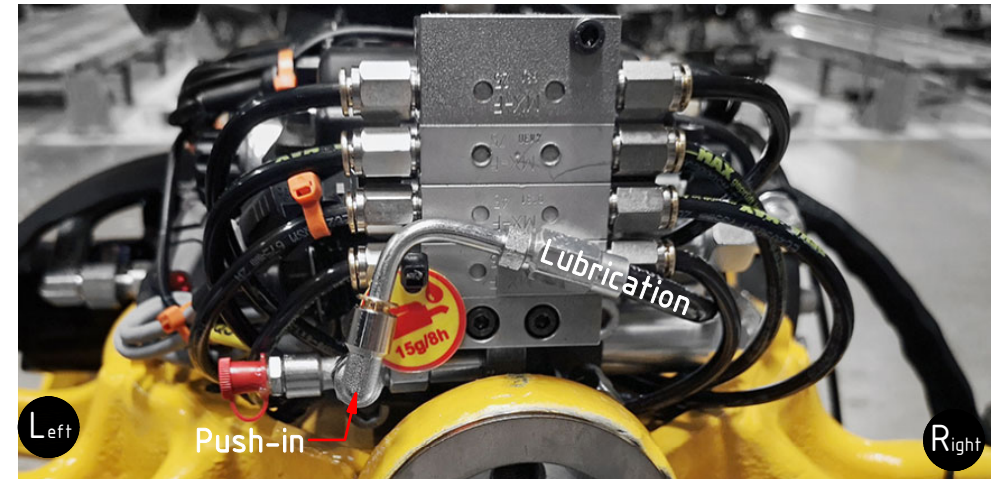
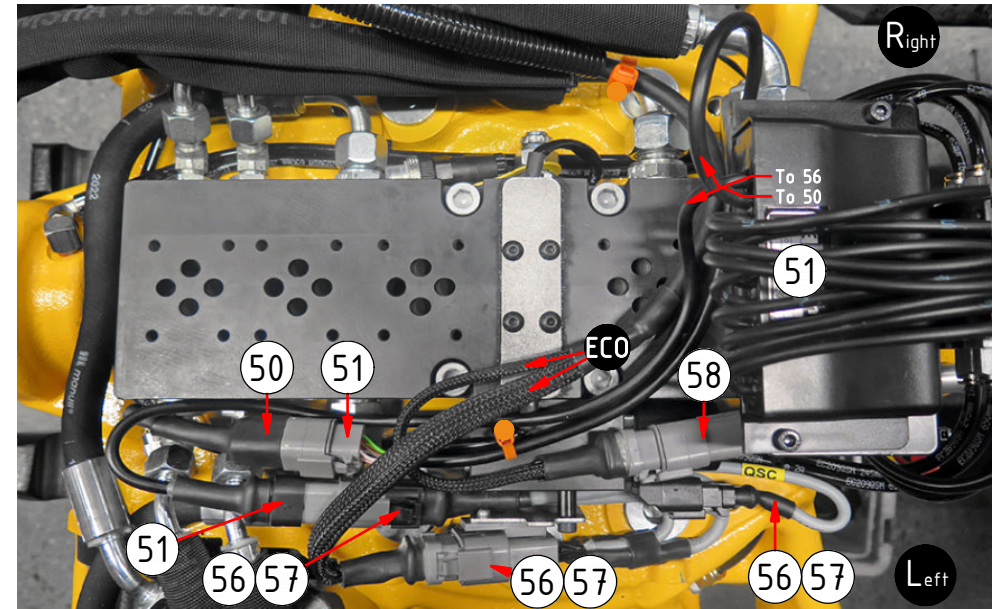

Valves

POS	DESCRIPTION	PART	QTY	COMMENTS
●	Use cable ties			

POS in order of assembly

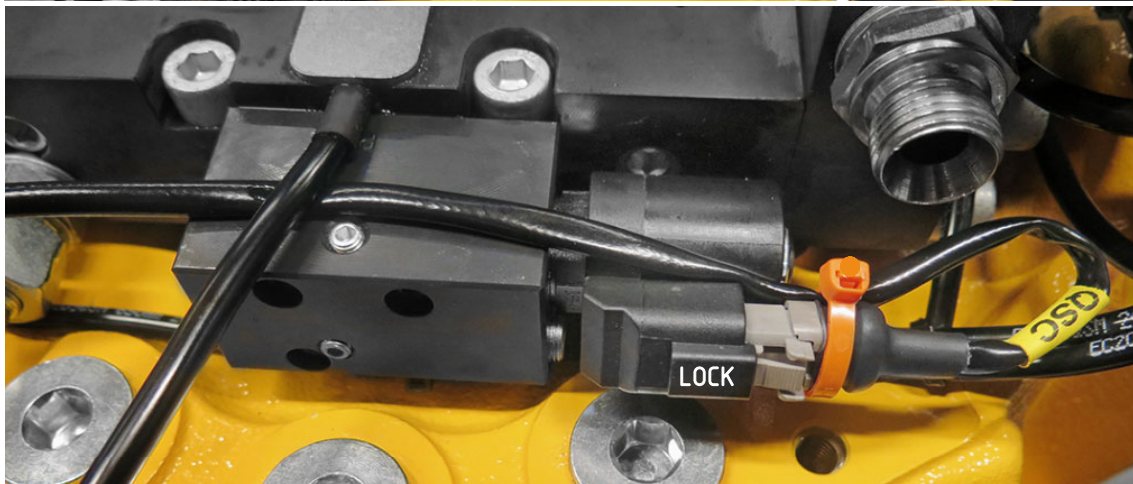

special/options

POS	DESCRIPTION	PART	QTY	COMMENTS
47	Remove Protective cap			Part of Quick hitch
48	Hose Drain	7001276	1	Without EC-Oil
49	Hose Drain ECO	7001275	1	With EC-Oil

POS in order of assembly

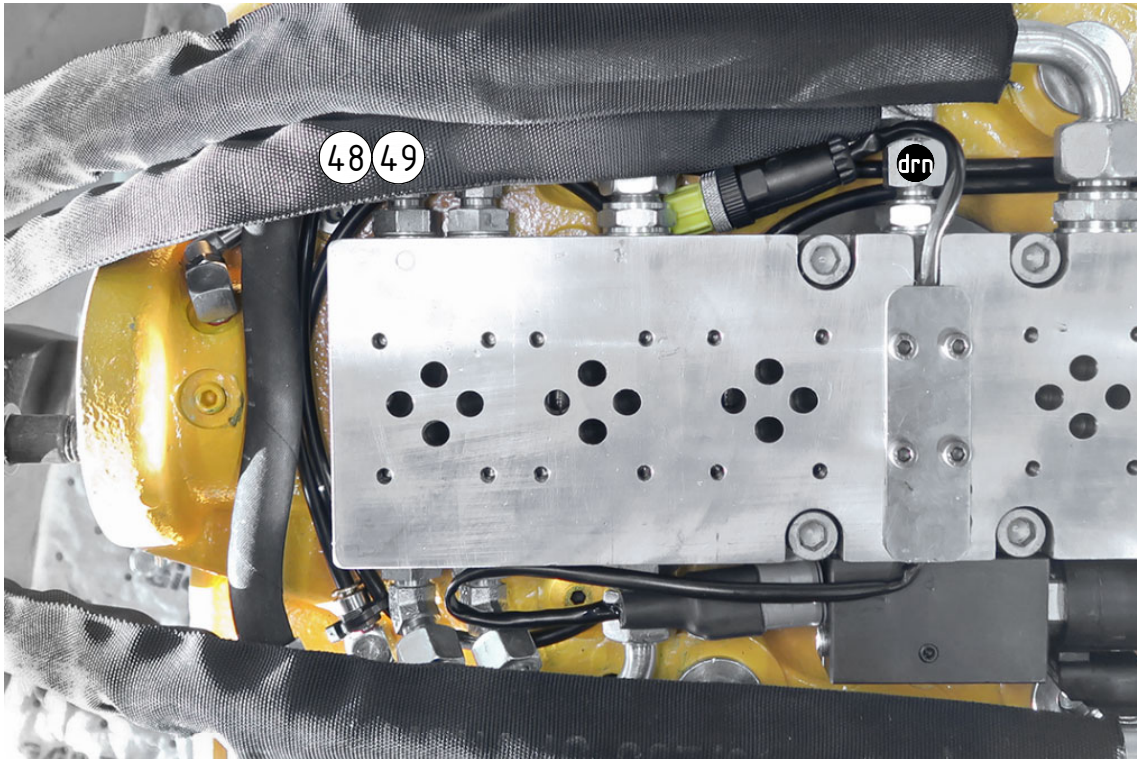

SPARE PARTS

ss10 (DC2/SVAB)

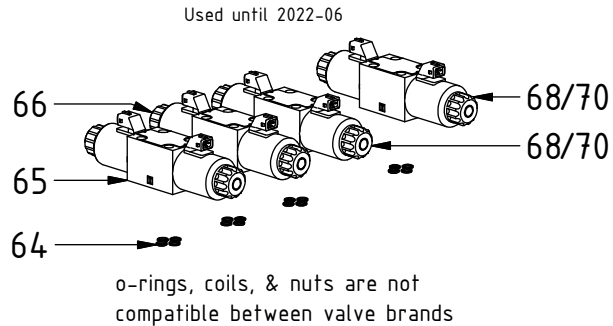

EC209PS DC2:

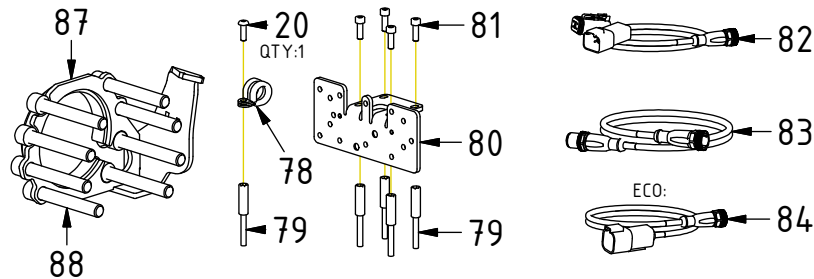

EC209PS ss10 (SVAB):

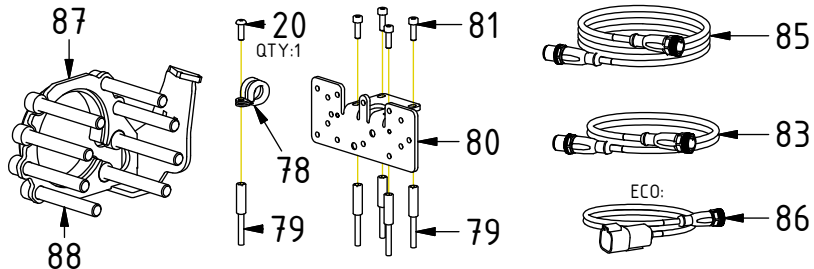

POS	DESCRIPTION	PART	QTY	COMMENTS
20	Screw K6S M5x16 10.9 FZB	611818	2	Torque: 8,1Nm
22	Directional valve prop 12V open T	7001615	1	(POS.21, 26, 29 incl.)
23	Directional valve prop 12V	7001614	1	(POS.21, 26, 29 incl.)
24	Directional valve NG6 12V	7001617	2	(POS.21, 27, 29 incl.)
25	Directional valve NG6 24V	7001616	2	(POS.21, 28, 29 incl.)
54	Aggregate cable DC2 Compl. QSC DT	8001201	1	
55	ILME cover 12P contact with jumper	810208	1	(Incl. with agg.cable)
64	O-ring 9,25x1,78	710901	16	Used until 2022-06
65	Argo hytos valve prop 12V open T	7000092	1	Replaced by POS.22 (ATOS)
66	Argo hytos valve prop 12V	730190	1	Replaced by POS.23 (ATOS)
67	Argo hytos Coil 12V prop JT	730192	4	Used with POS.65-66
68	Argo hytos valve NG6 12V	730101	2	Replaced by POS.24 (ATOS)
69	Coil 12V JT	730117	4	Used with POS.68
70	Argo hytos valve NG6 24V	730103	2	Replaced by POS.25 (ATOS)
71	Coil 24V JT	730118	4	Used with POS.70
72	Nut directional valve	730135	8	
73	Aggregate cable DC2 Comp. QSC JT	8000175	1	Replaced by POS.54 from 2020-12
74	Cable QS QLM tiltrotator SVAB	842148	1	
75	Aggregate cable SVAB Complete	303465	1	
76	Adapter cable JT>DT	1017478	1	(Previously also for DC2)
77	Adapter cable ECO (DTM) SVAB	1029599	1	For EC-Oil. Instead of POS.74-75
78	Rubber steel clamp ø16	6000009	1	
79	Valve spacer	1034402	5	
80	Plate EC209PS QSM	1057538	1	
81	Screw MC6S M5x16 12.9	610401	4	
82	Adapter cable DC2 ePS	8000783	1	
83	Adapter cable ePS rotation sensor	8000784	1	
84	Cable Tilt angle sensor ECO W DC2	8002459	1	For EC-Oil w. ePS NB! Only compatible with 8002477
85	Unit cable ePS w. 120 ohm termin.	8000824	1	
86	Ad.cable ePS ECOw SVAB 120 ohm	8000825	1	For ECO w. ePS. Instead of POS.85
87	Protection EC209PS	1033565	1	
88	Screw MC6S M12x80 12.9 ZFSL	6000148	8	Torque: 136Nm

