

Planned document changes:

Briefly:

No planned changes.

Document changes:

Date:	Change:	Rev. after change:
2023-08-15	Photos added.	E
2023-03-14	Y-split replaced. Cables added.	D
2022-09-30	Glue info updated.	C
2022-08-31	Torque updated.	B
2022-06-14	Sensor clarification.	A
2022-05-11	New document.	-

Readers note:

Indicates instruction.



Represents Hose.

Dashed lines for overview, mounts
on other pages/assemblies.

EC206B

POS	DESCRIPTION	PART	QTY	COMMENTS
1	Magnet screw - Rot./Tilt sensor	8001547	2	Loxal 83-52. Torque: 10Nm
2	Rotation sensor	8001543	1	White side against magnet
3	Tilt angle sensor	8001544	1	White side against magnet
4	K6S M4x16 10.9 FZB	6000368	4	Loxal 55-02
5	Adapter cable tilt sensor 600mm	8001610	1	Cable cover: 405mm for EC206B, 495mm for EC209B
7	Power Plug ECO40 W Left 2x M12	8001885	1	Part of EC-Oil components
9	Y-split M12 EVC614	1069559	1	
10	Adapter cable DC2	8000783	1	
11	Ad.cable ss9/SVAB ECOW 120 ohm	8000825	1	
12	Ad.cable ss9/SVAB w. 120 ohm ter.	8000824	1	

POS in order of assembly

Exploded view
Std. Top components

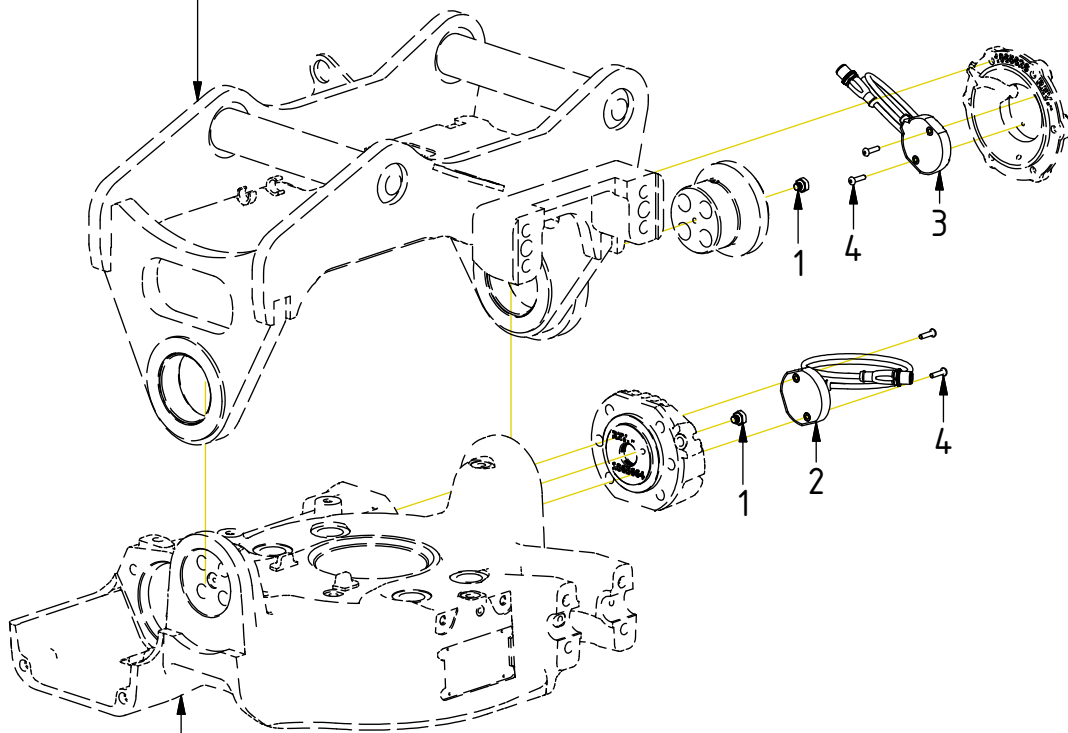

Exploded view
Rotator frame

DC2 EC-Oil:

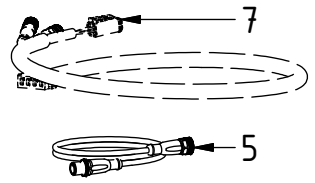

DC2 without EC-Oil:

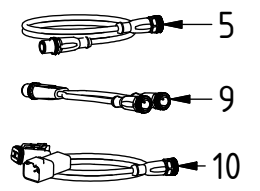

ss9/ss10(SVAB) EC-Oil:

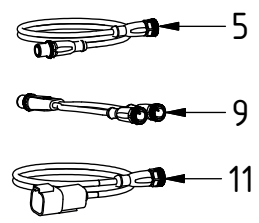

ss9/ss10(SVAB) without EC-Oil:

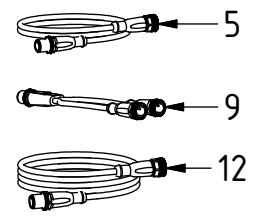

EC209B-EC233

- 13
- 14

POS	DESCRIPTION	PART	QTY	COMMENTS
1	Magnet screw - Rot./Tilt sensor	8001547	2	Loxael 83-52. Torque: 10Nm
2	Rotation sensor	8001543	1	White side against magnet
3	Tilt angle sensor	8001544	1	White side against magnet
4	K6S M4x16 10.9 FZB	6000368	4	Loxael 55-02
5	Adapter cable tilt sensor 600mm	8001610	1	Cable cover: 405mm for EC206B, 495mm for EC209B
6	Adapter cable tilt sensor 1200mm	8001611	1	Cable cover: 800mm for EC214-233
8	Adapter cable ECO W DC2 ePS2	8001847	1	Part of Control system
9	Y-split M12 EVC614	1069559	1	
10	Adapter cable DC2	8000783	1	
11	Ad.cable ss9/SVAB ECOW 120 ohm	8000825	1	
12	Ad.cable ss9/SVAB w. 120 ohm ter.	8000824	1	
13	Rubber steel clamp \varnothing 14	613009	1	
14	K6S M5x8 10.9 FZB	611801	1	

POS in order of assembly

Exploded view
Std. Top components

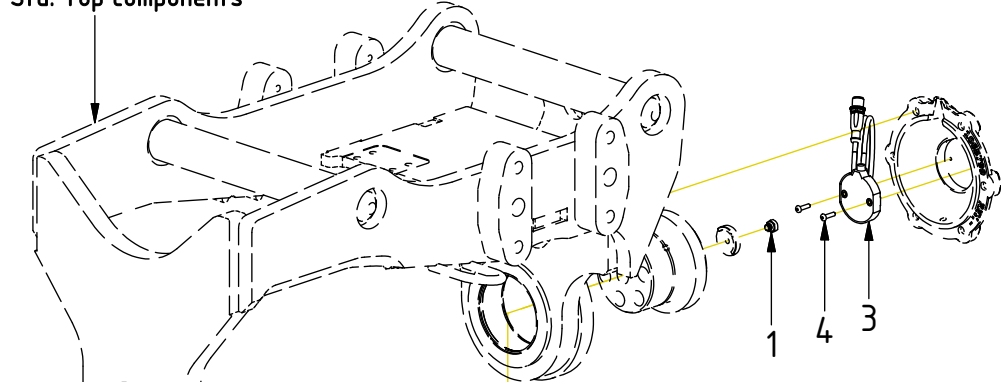

Exploded view
Rotator frame

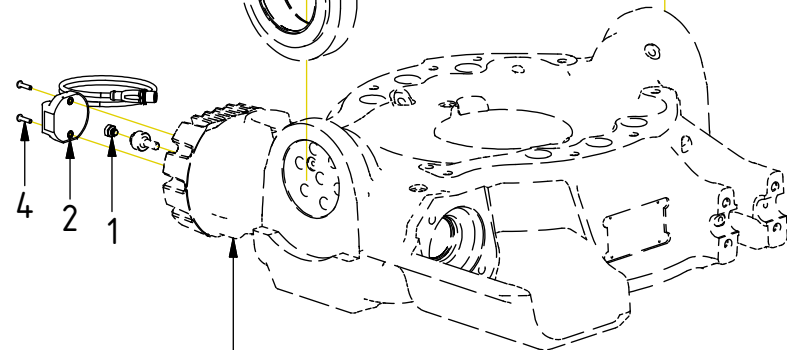

DC2 EC-Oil:

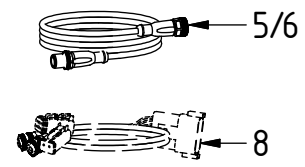

DC2 without EC-Oil:

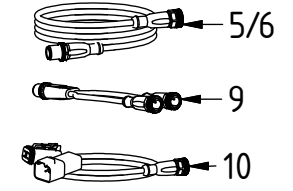

ss9/ss10(SVAB) EC-Oil:

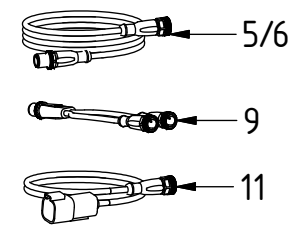

ss9/ss10(SVAB) without EC-Oil:

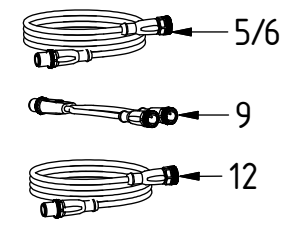

EC206B
DC2 EC-Oil

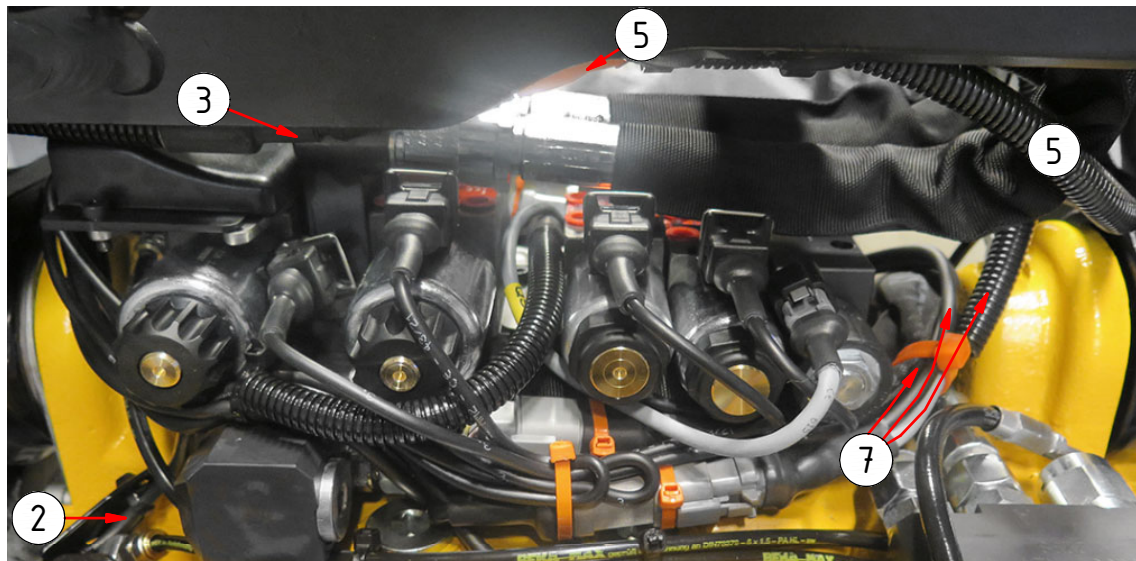
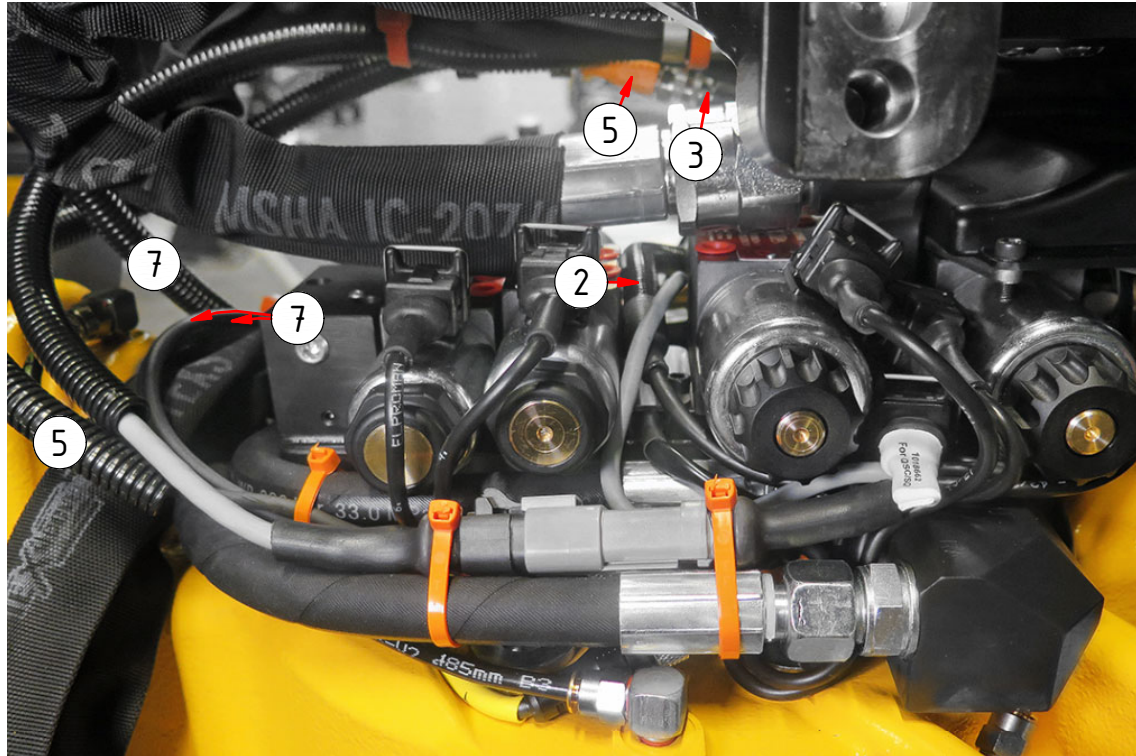

POS	DESCRIPTION	PART	QTY	COMMENTS
2	Rotation sensor	8001543	1	White side against magnet
3	Tilt angle sensor	8001544	1	White side against magnet
5	Adapter cable tilt sensor 600mm	8001610	1	Cable cover: 405mm for EC206B, 495mm for EC209B
7	Power Plug ECO40 W Left 2x M12	8001885	1	Part of EC-Oil components
9	Y-split M12 EVC614	1069559	1	
10	Adapter cable DC2	8000783	1	
●	Use cable ties			

DC2 without EC-Oil:

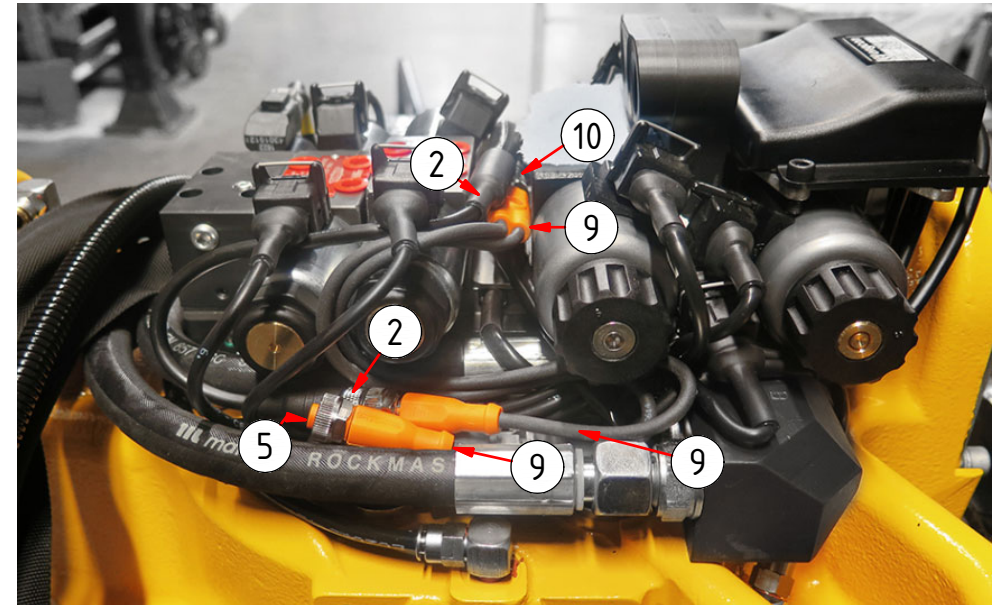

UNI:

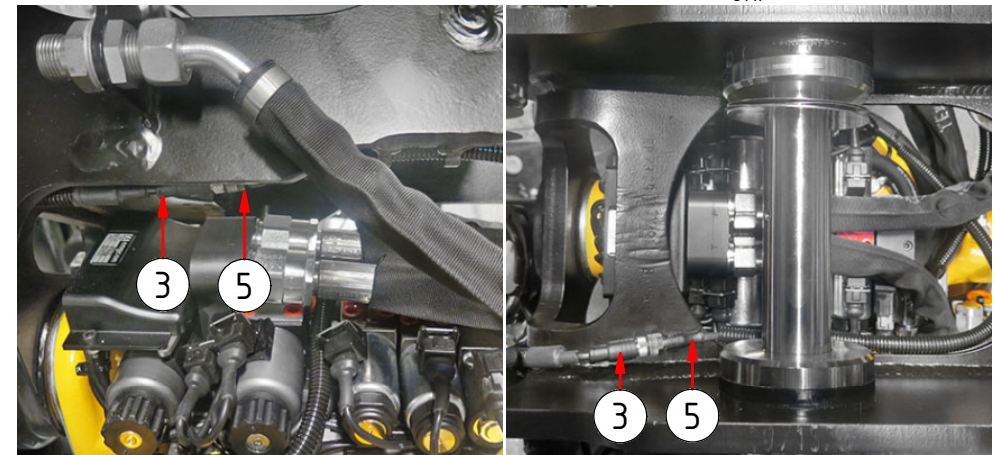

POS in order of assembly

EC206B

ss9/ss10 (SVAB) EC-Oil

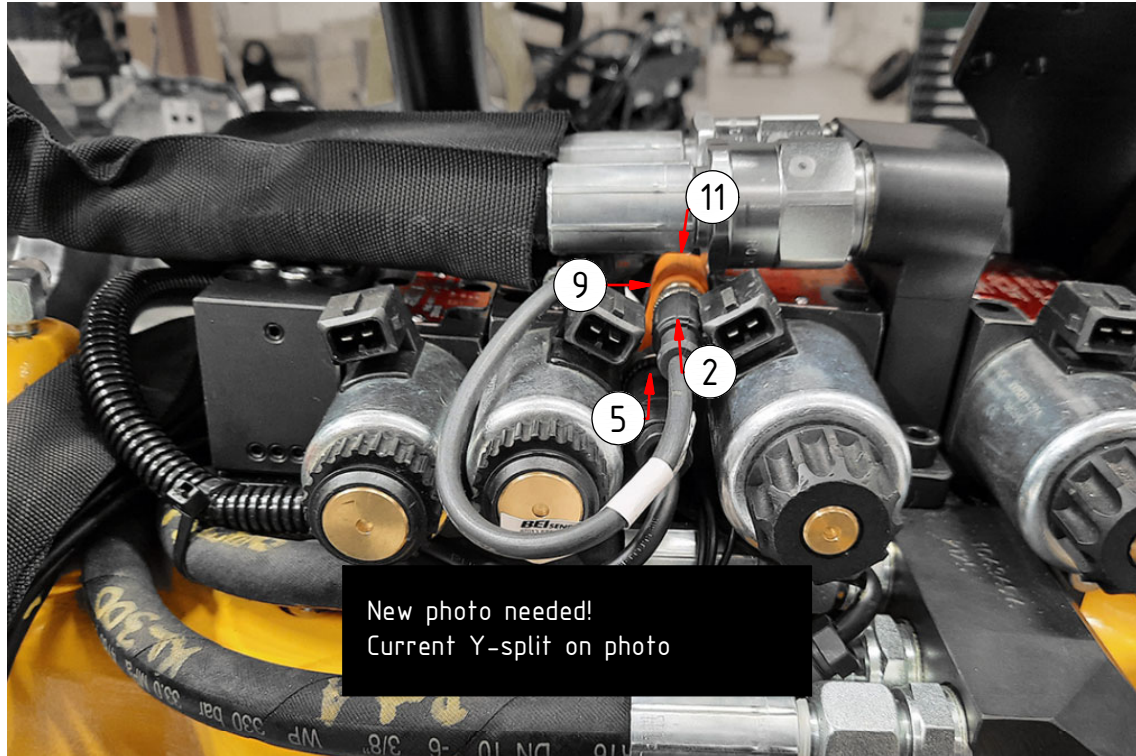

POS	DESCRIPTION	PART	QTY	COMMENTS
2	Rotation sensor	8001543	1	White side against magnet
3	Tilt angle sensor	8001544	1	White side against magnet
5	Adapter cable tilt sensor 600mm	8001610	1	Cable cover: 405mm for EC206B, 495mm for EC209B
9	Y-split M12 EVC614	1069559	1	
11	Ad.cable ss9/SVAB ECOW 120 ohm	8000825	1	
12	Ad.cable ss9/SVAB w. 120 ohm ter.	8000824	1	

ss9/ss10 (SVAB) without EC-Oil:

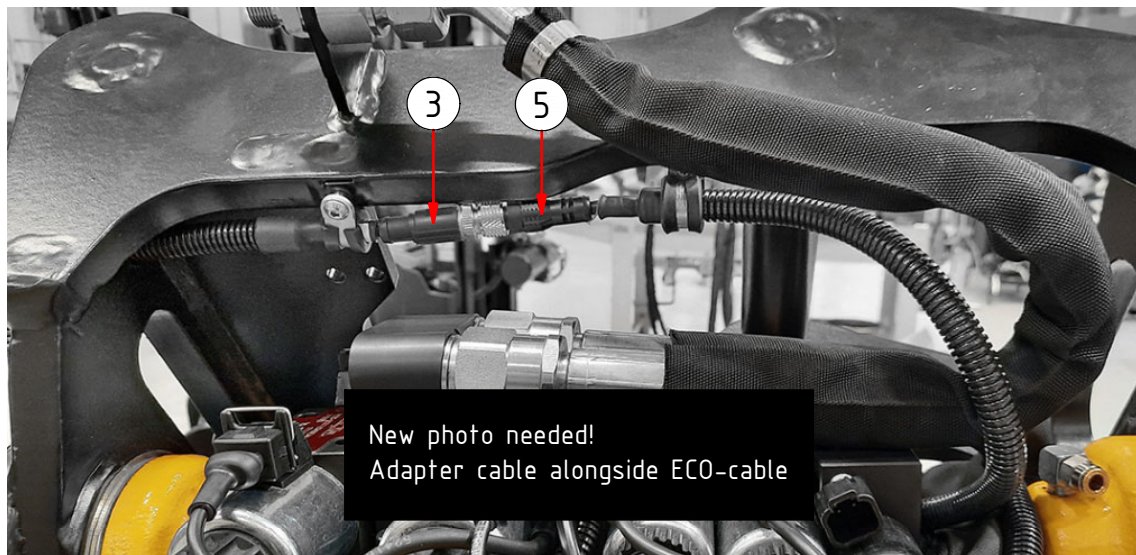
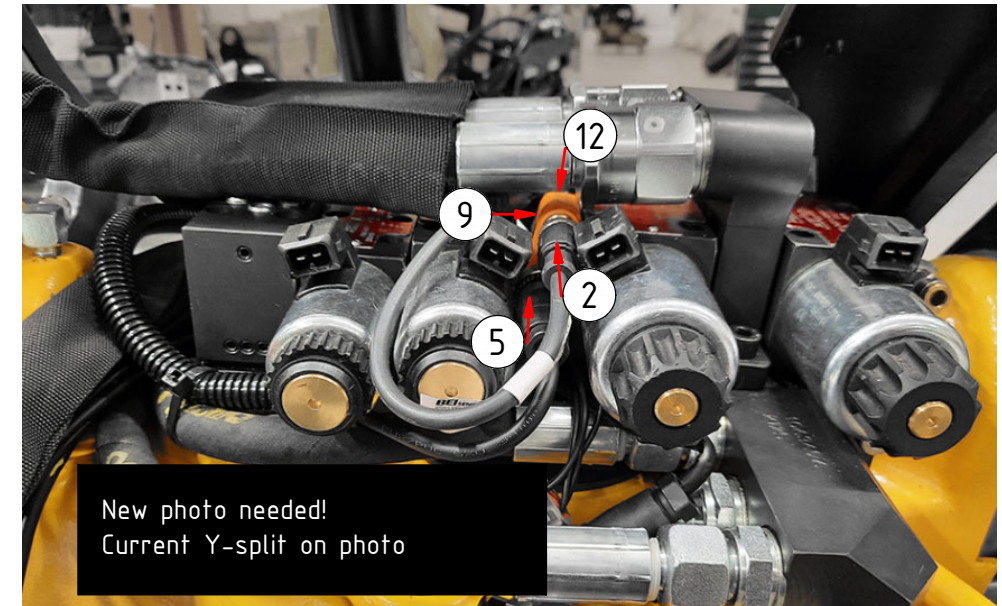

UNI:

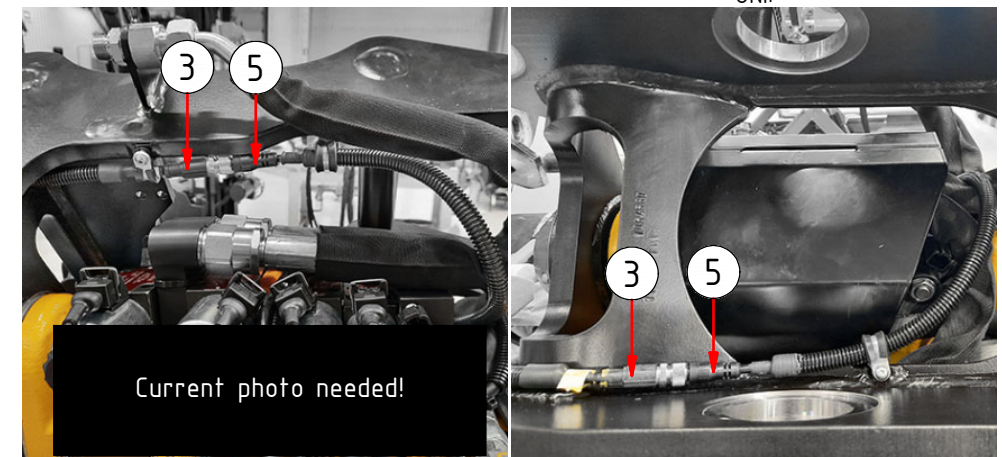

POS in order of assembly

EC209B
DC2 EC-Oil

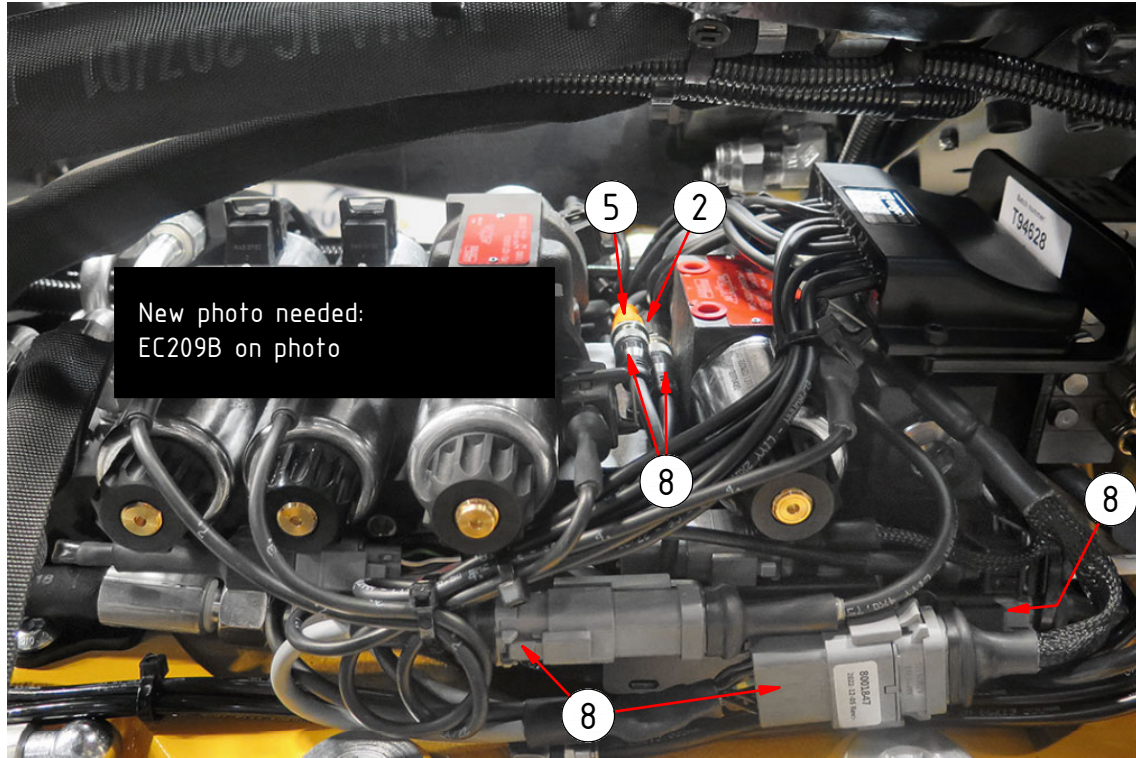

POS	DESCRIPTION	PART	QTY	COMMENTS
2	Rotation sensor	8001543	1	White side against magnet
3	Tilt angle sensor	8001544	1	White side against magnet
5	Adapter cable tilt sensor 600mm	8001610	1	Cable cover: 405mm for EC206B, 495mm for EC209B
8	Adapter cable ECO W DC2 ePS2	8001847	1	Part of Control system
9	Y-split M12 EVC614	1069559	1	
10	Adapter cable DC2	8000783	1	
●	Use cable ties			

POS in order of assembly

DC2 without EC-Oil:

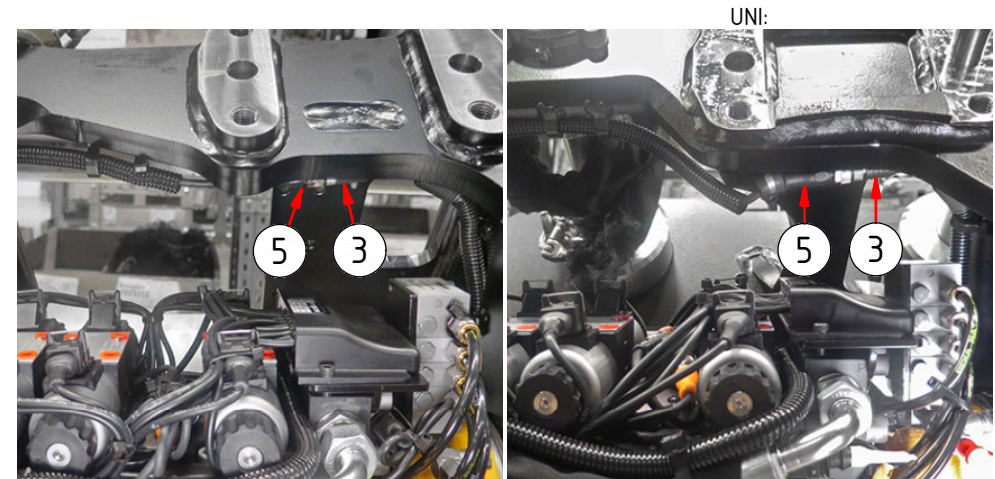
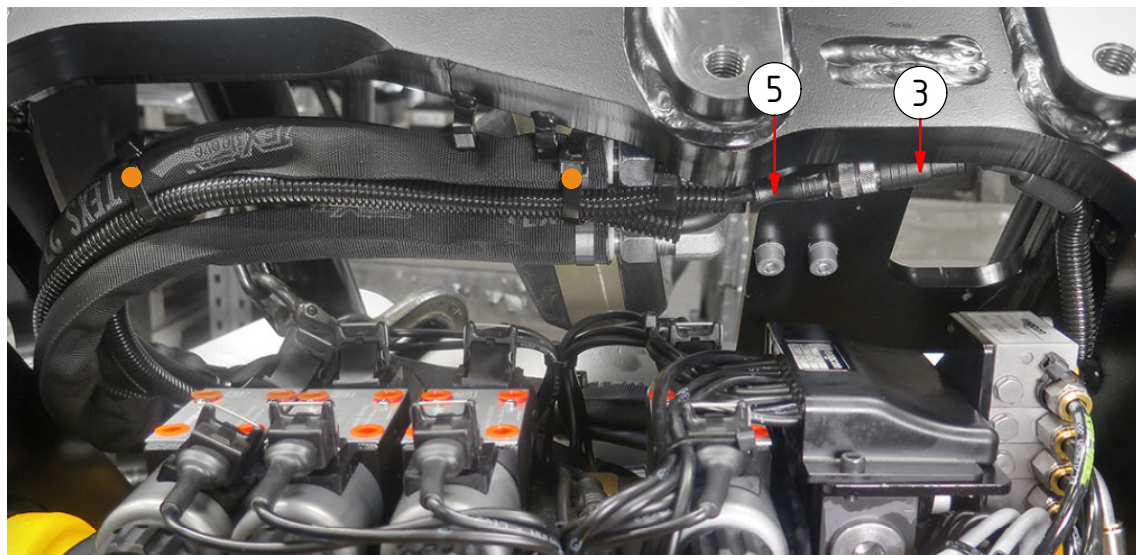
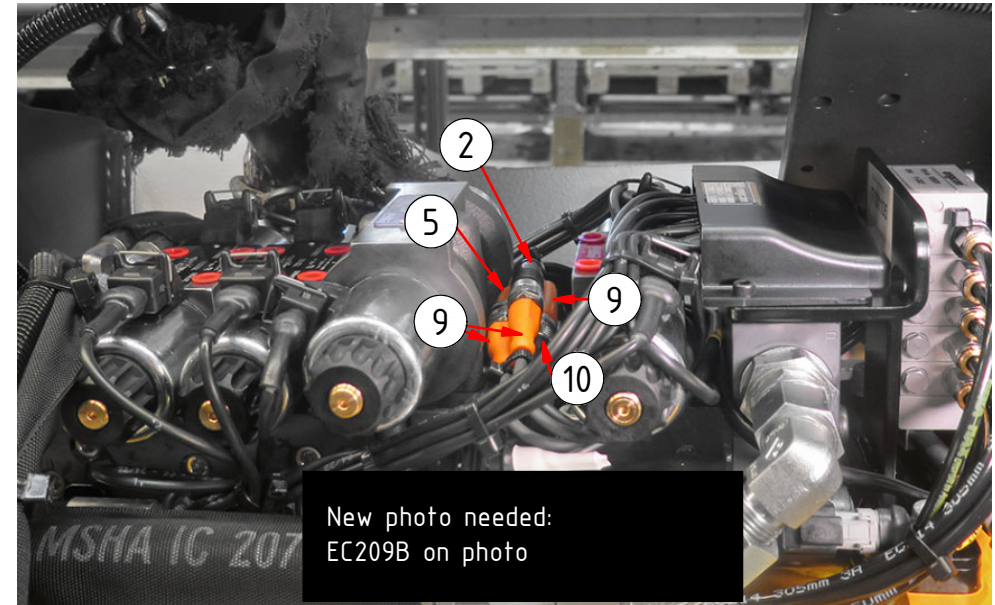

UNI:

EC209B

ss9/ss10 (SVAB) EC-Oil

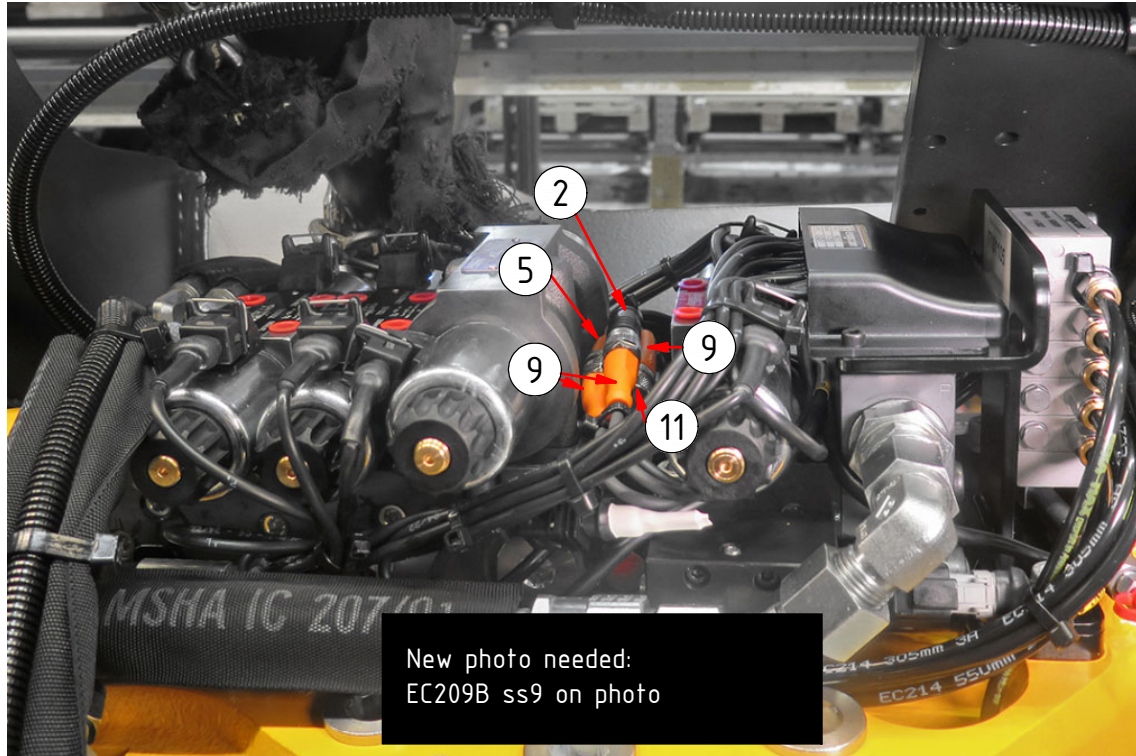

New photo needed:
EC209B ss9 on photo

POS	DESCRIPTION	PART	QTY	COMMENTS
2	Rotation sensor	8001543	1	White side against magnet
3	Tilt angle sensor	8001544	1	White side against magnet
5	Adapter cable tilt sensor 600mm	8001610	1	Cable cover: 405mm for EC206B, 495mm for EC209B
9	Y-split M12 EVC614	1069559	1	
11	Ad.cable ss9/SVAB ECOW 120 ohm	8000825	1	
12	Ad.cable ss9/SVAB w. 120 ohm ter.	8000824	1	
●	Use cable ties			

POS in order of assembly

ss9/ss10 (SVAB) without EC-Oil:

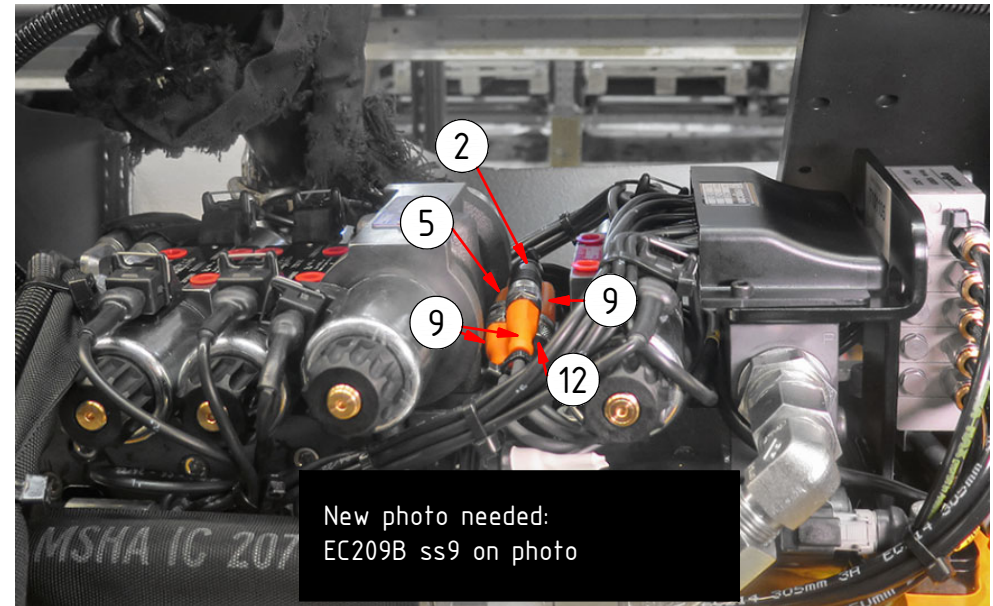

New photo needed:
EC209B ss9 on photo

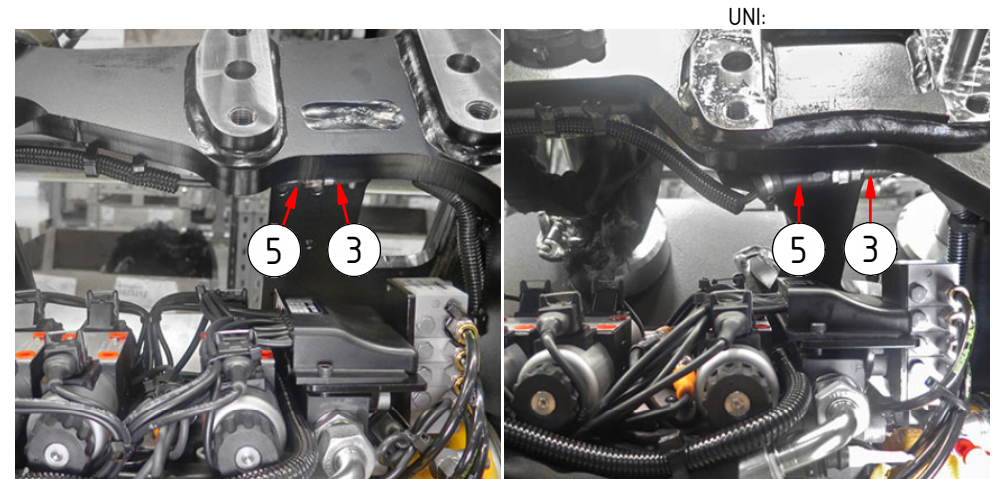
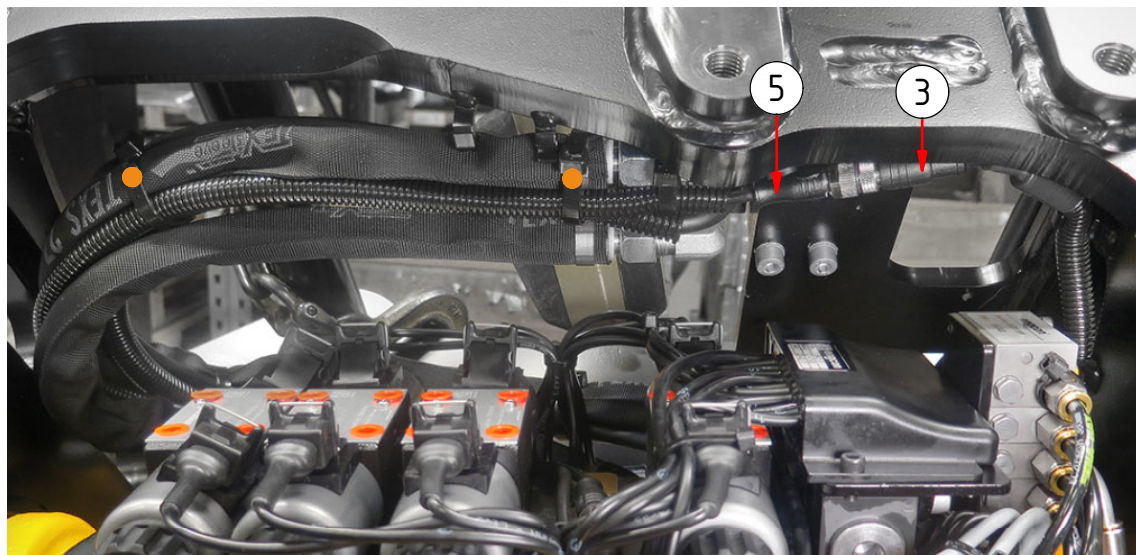

EC214-EC219

DC2 EC-Oil

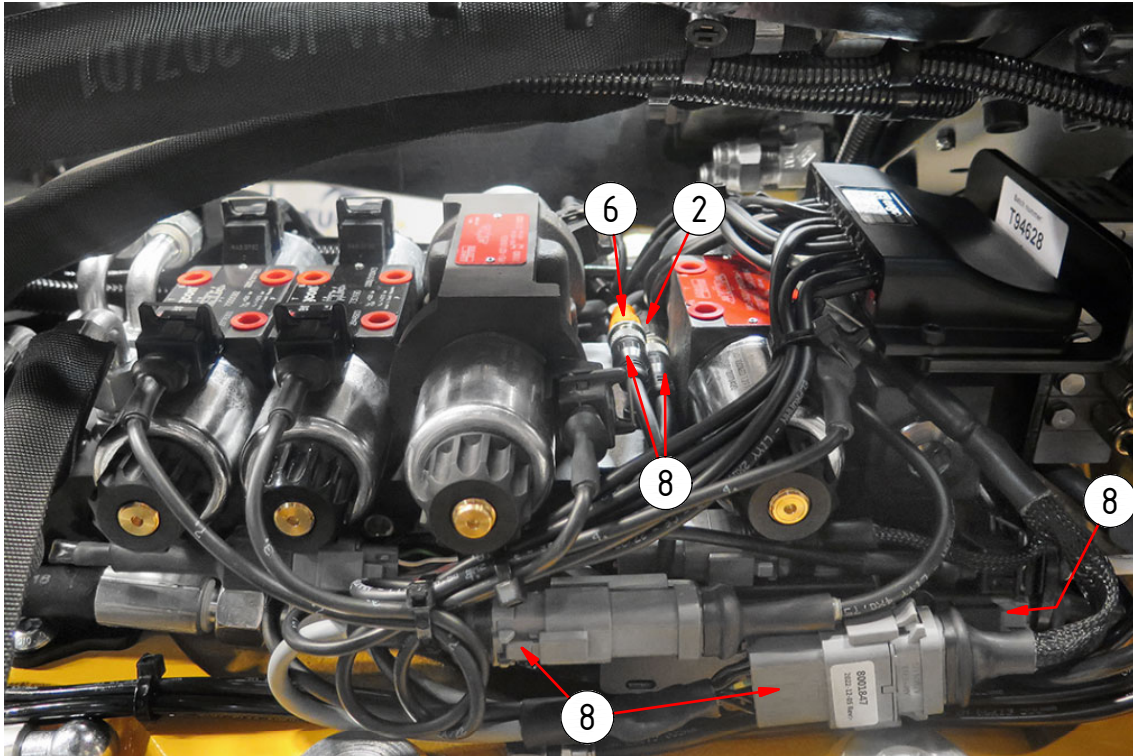

POS	DESCRIPTION	PART	QTY	COMMENTS
2	Rotation sensor	8001543	1	White side against magnet
3	Tilt angle sensor	8001544	1	White side against magnet
6	Adapter cable tilt sensor 1200mm	8001611	1	Cable cover: 800mm for EC214-233
8	Adapter cable ECO W DC2 ePS2	8001847	1	Part of Control system
9	Y-split M12 EVC614	1069559	1	
10	Adapter cable DC2	8000783	1	
●	Use cable ties			

POS in order of assembly

DC2 without EC-Oil:

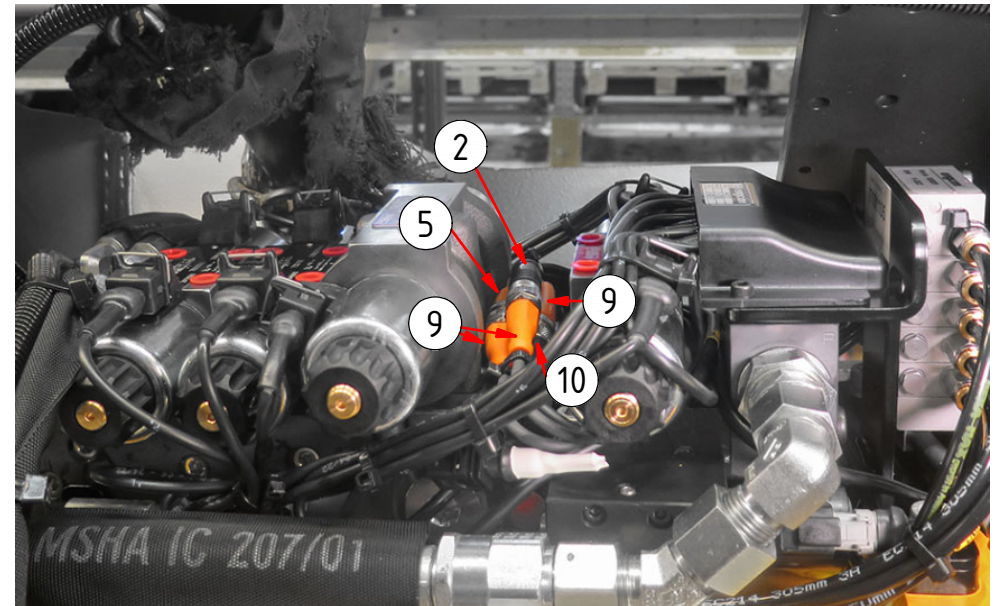

EC214:

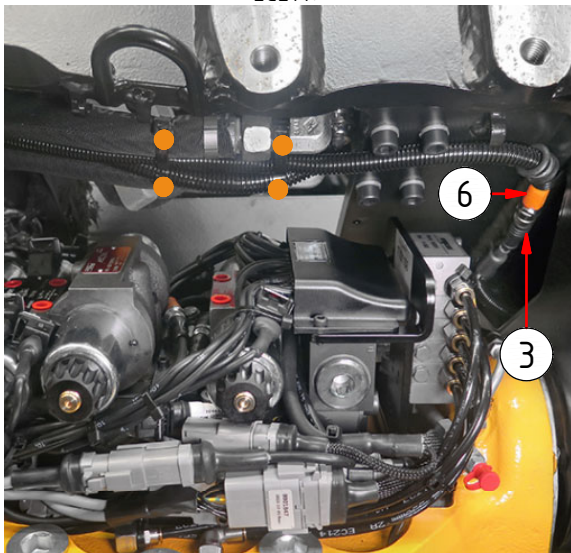

EC219:

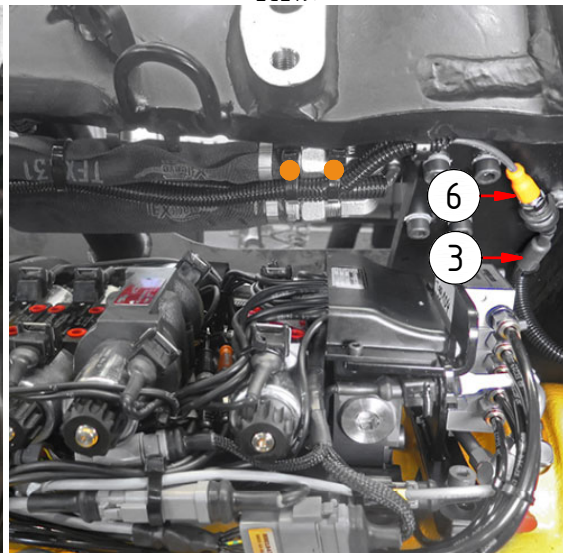

EC214:

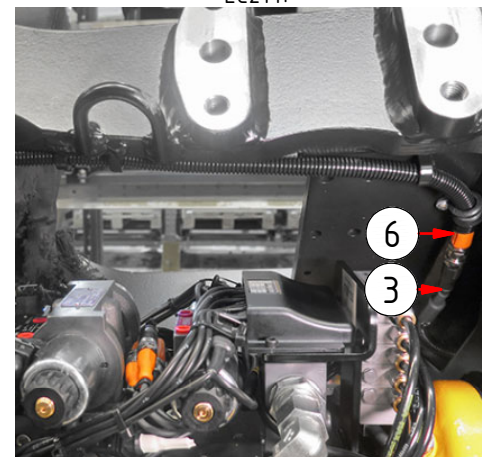

EC219:

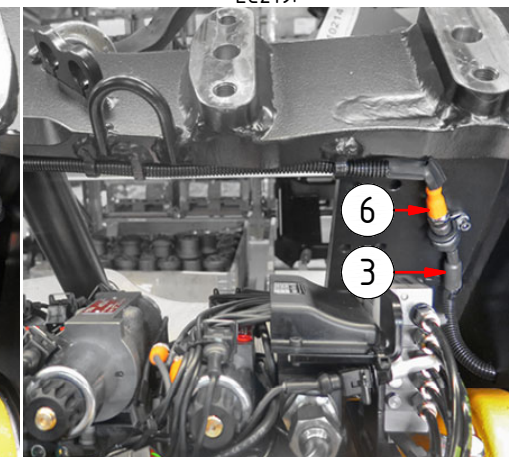

EC214-EC219

ss9/ss10 (SVAB) EC-Oil

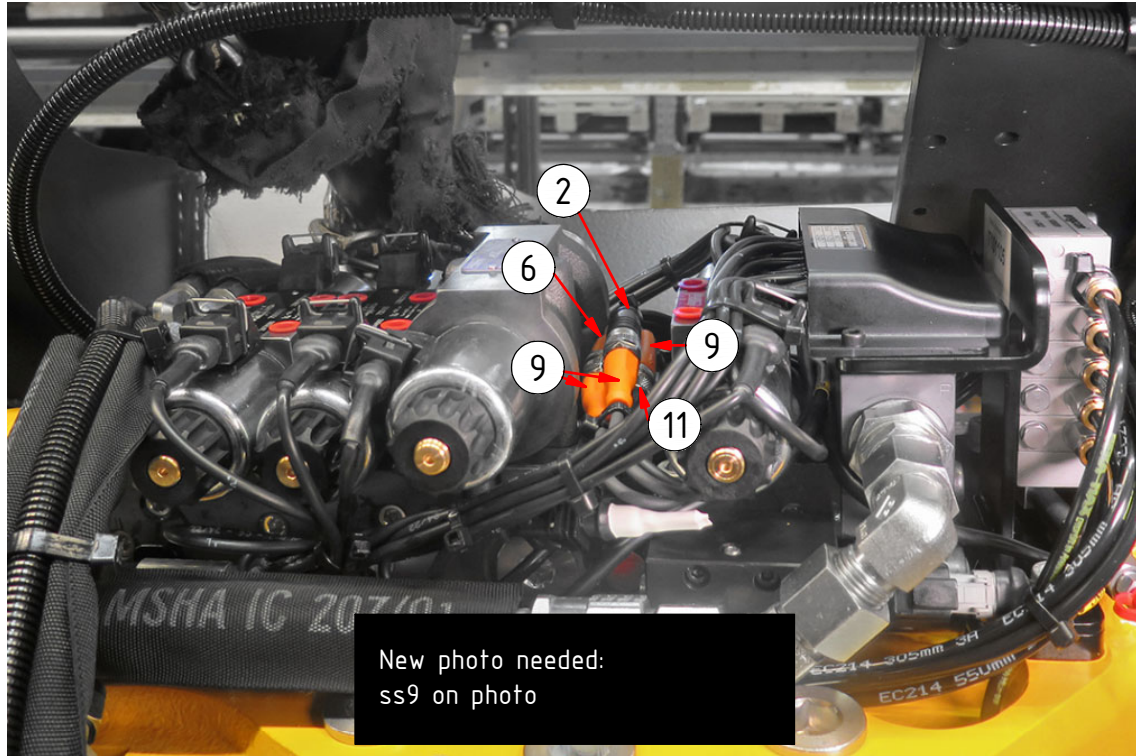

POS	DESCRIPTION	PART	QTY	COMMENTS
2	Rotation sensor	8001543	1	White side against magnet
3	Tilt angle sensor	8001544	1	White side against magnet
6	Adapter cable tilt sensor 1200mm	8001611	1	Cable cover: 800mm for EC214-233
9	Y-split M12 EVC614	1069559	1	
11	Ad.cable ss9/SVAB ECOW 120 ohm	8000825	1	
12	Ad.cable ss9/SVAB w. 120 ohm ter.	8000824	1	
●	Use cable ties			

ss9/ss10 (SVAB) without EC-Oil:

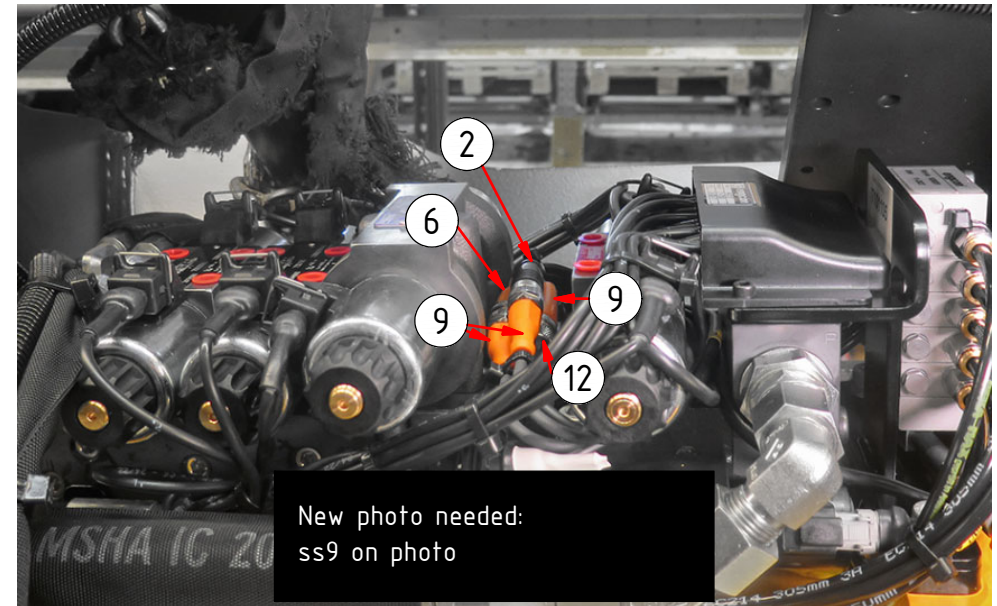

EC214:

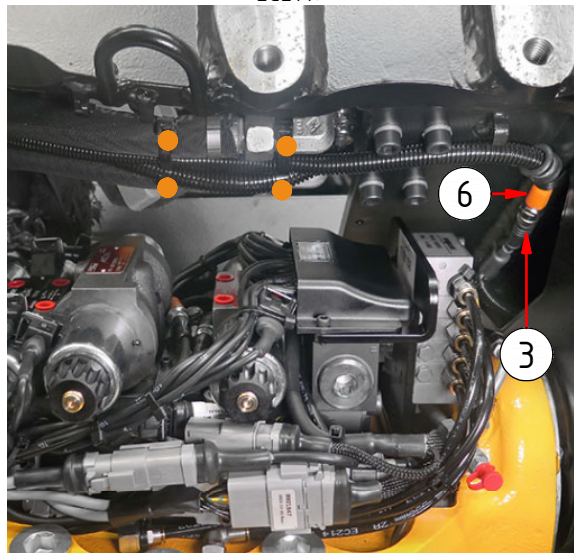

EC219:

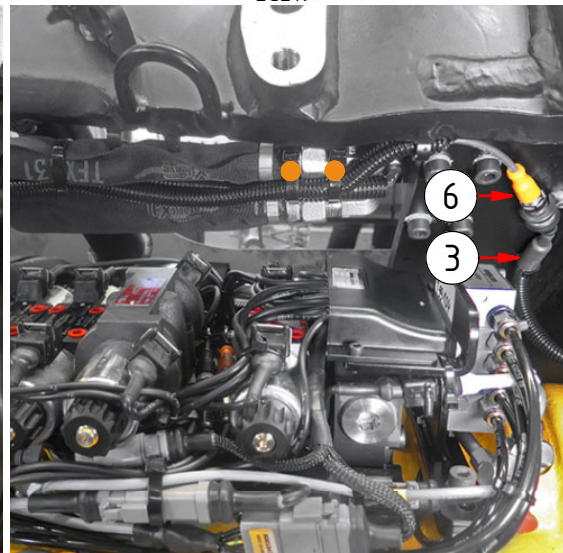

EC214:

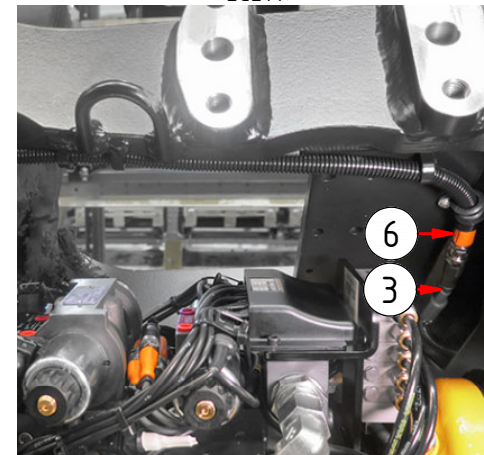

EC219:

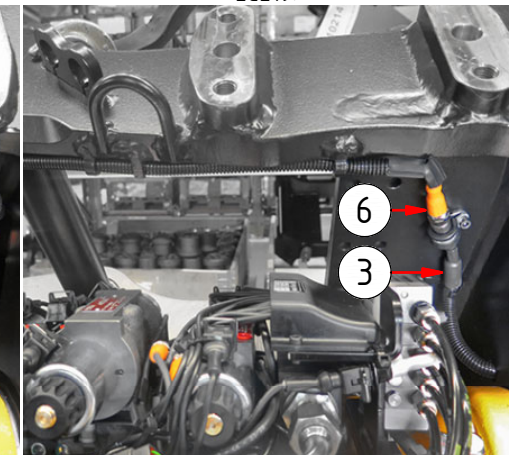

EC226-EC233
DC2 EC-Oil

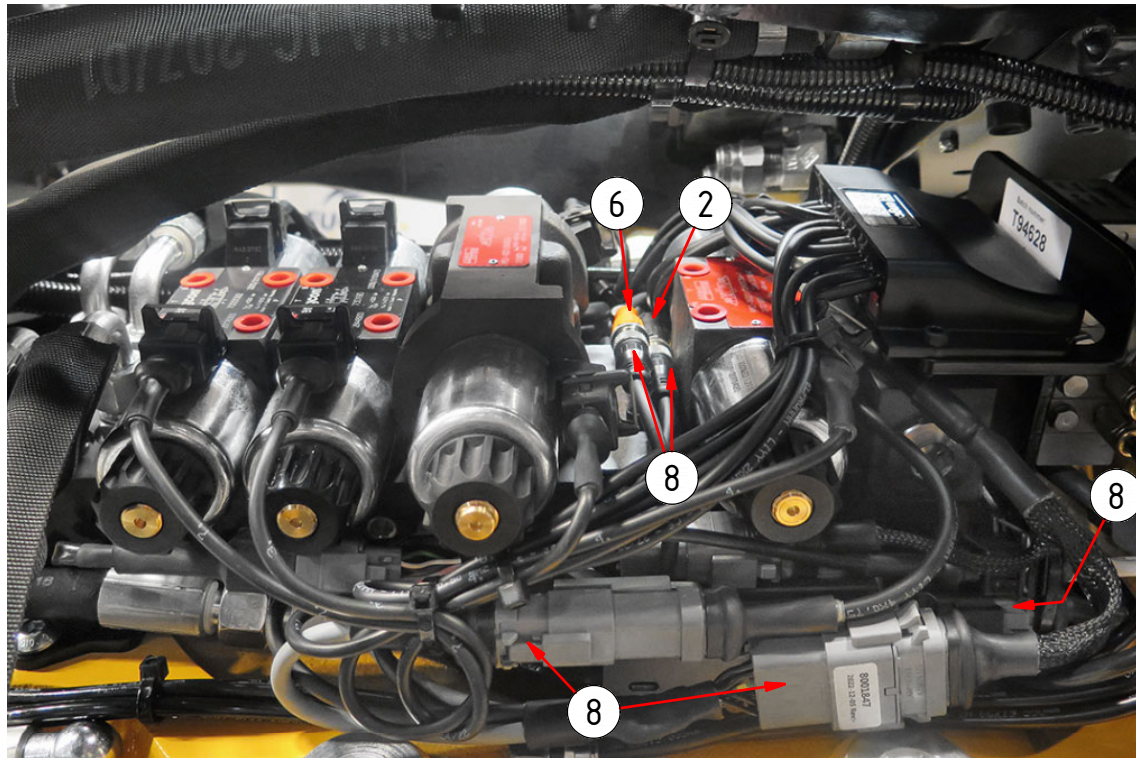

POS	DESCRIPTION	PART	QTY	COMMENTS
2	Rotation sensor	8001543	1	White side against magnet
3	Tilt angle sensor	8001544	1	White side against magnet
6	Adapter cable tilt sensor 1200mm	8001611	1	Cable cover: 800mm for EC214-233
8	Adapter cable ECO W DC2 ePS2	8001847	1	Part of Control system
9	Y-split M12 EVC614	1069559	1	
10	Adapter cable DC2	8000783	1	
●	Use cable ties			

POS in order of assembly

DC2 without EC-Oil:

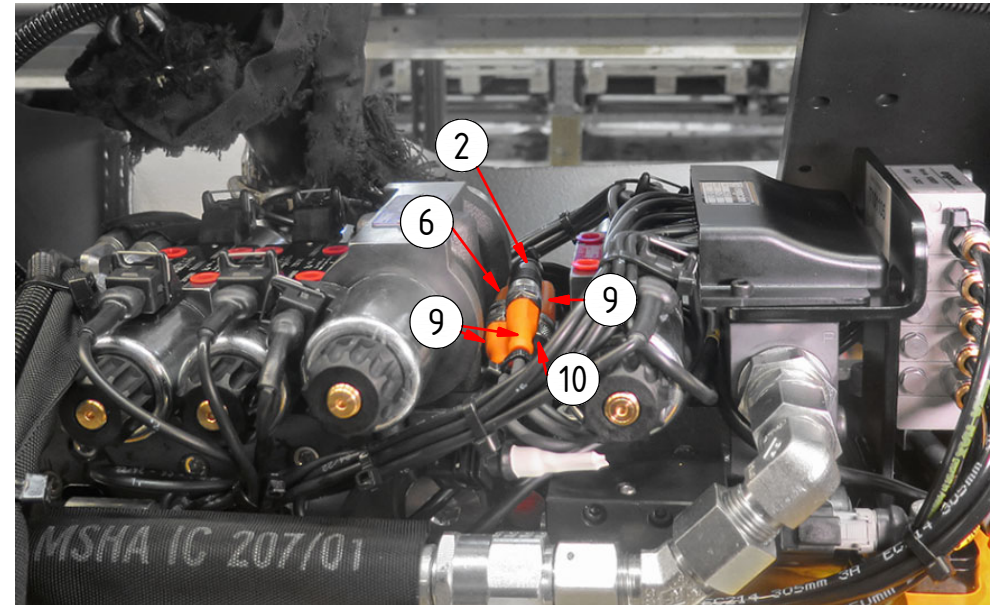

EC226:

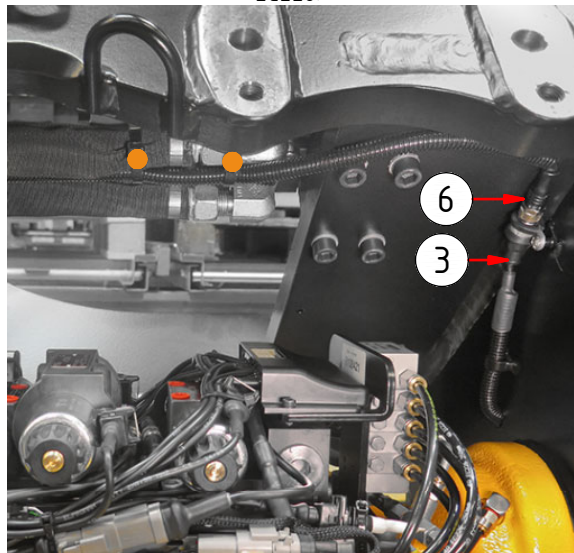

EC233:

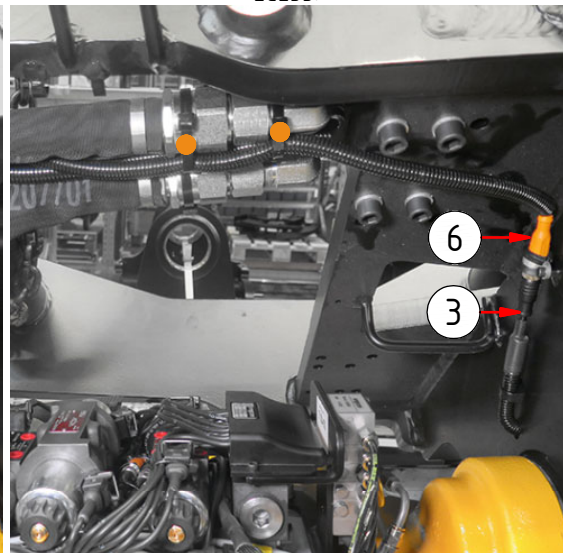

EC226-EC233

ss9/ss10 (SVAB) EC-Oil

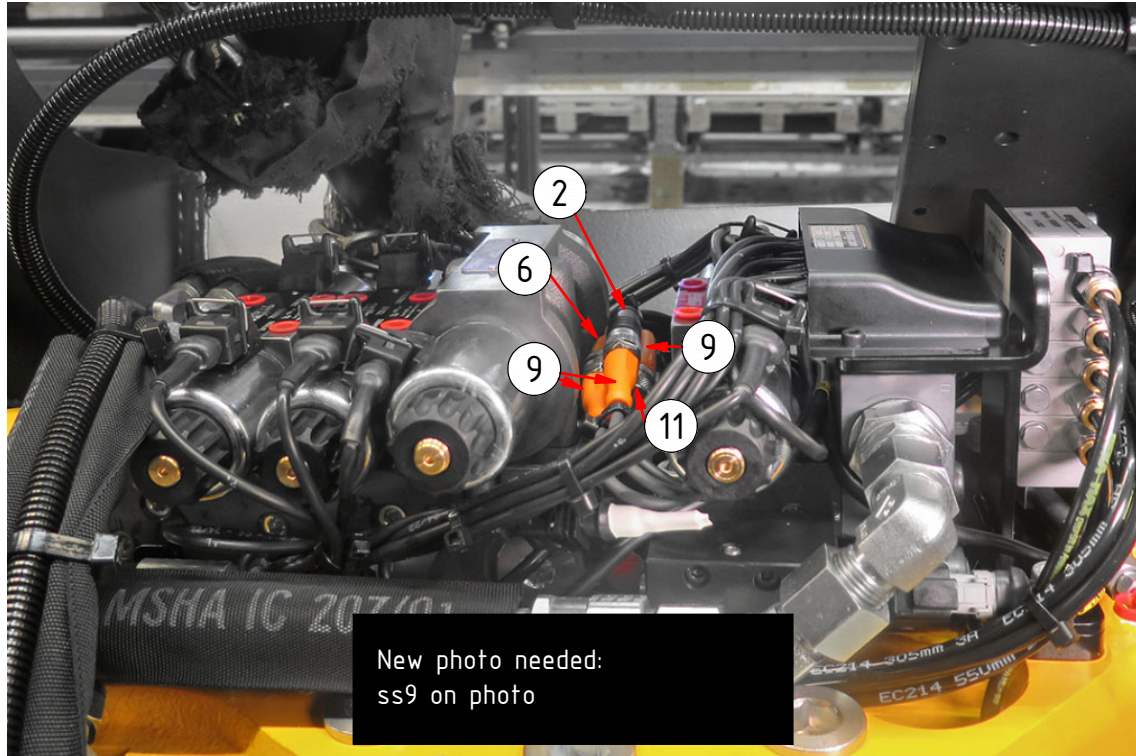

POS	DESCRIPTION	PART	QTY	COMMENTS
2	Rotation sensor	8001543	1	White side against magnet
3	Tilt angle sensor	8001544	1	White side against magnet
6	Adapter cable tilt sensor 1200mm	8001611	1	Cable cover: 800mm for EC214-233
9	Y-split M12 EVC614	1069559	1	
11	Ad.cable ss9/SVAB ECOW 120 ohm	8000825	1	
12	Ad.cable ss9/SVAB w. 120 ohm ter.	8000824	1	
●	Use cable ties			

ss9/ss10 (SVAB) without EC-Oil:

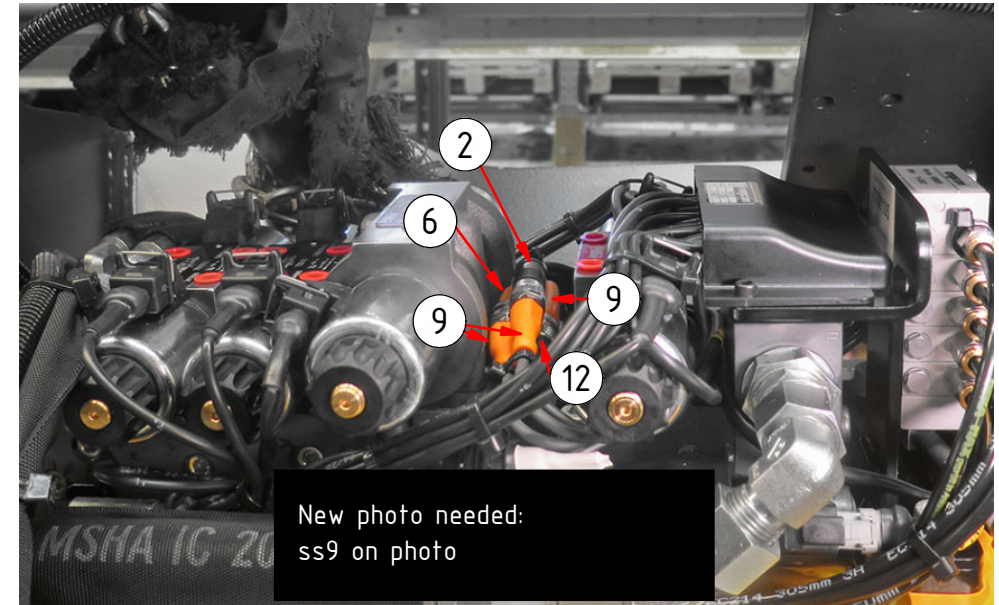

EC226:

EC233:

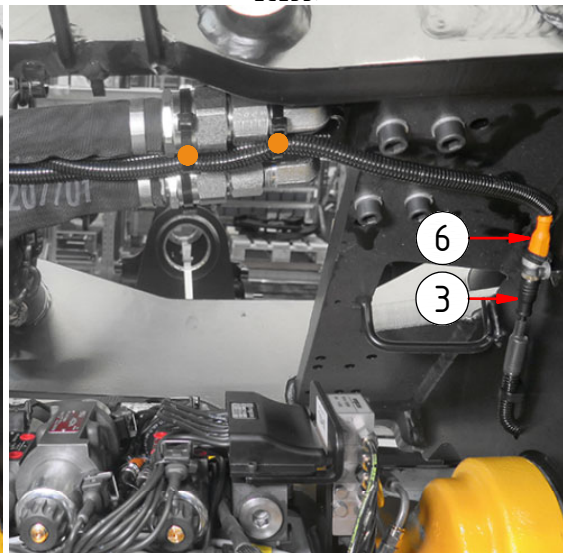
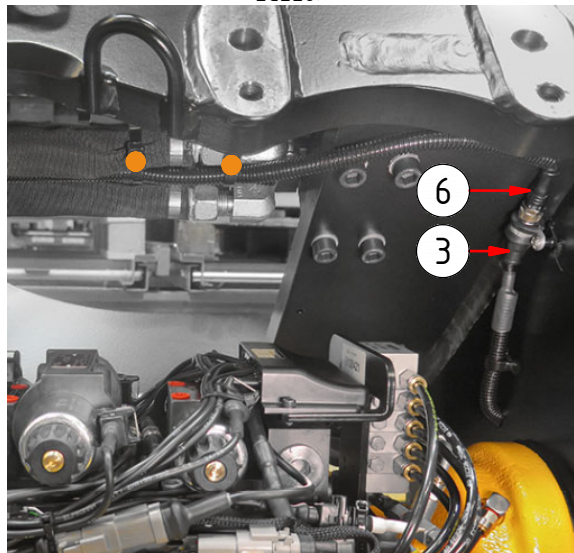

POS in order of assembly

SPARE PARTS

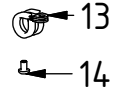

POS	DESCRIPTION	PART	QTY	COMMENTS
5	Adapter cable tilt sensor 600mm	8001610	1	Cable cover: 405mm for EC206B, 495mm for EC209B
6	Adapter cable tilt sensor 1200mm	8001611	1	Cable cover: 800mm for EC214-233
9	Y-split M12 EVC614	1069559	1	
10	Adapter cable DC2	8000783	1	
12	Ad.cable ss9/SVAB w. 120 ohm ter.	8000824	1	
13	Rubber steel clamp $\varnothing 14$	613009	1	
14	K6S M5x8 10.9 FZB	611801	1	
15	Y-split M12 EBC116	1065340	1	Replaced by POS.9

POS in order of assembly

DC2 with Y-split "EBC116":

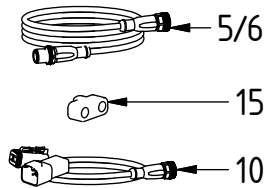

ss9/ss10 (SVAB) with Y-split "EBC116":

