

COVERSHEET

Planned document changes:

Briefly:

No planned changes.

Document changes:

Date:	Change:	Rev. after change:
2024-04-10	Adapters against cyl. added.	E
2023-09-21	Grab Open/Close corrected.	D
2021-04-08	Photos added.	C
2020-06-25	Part nos added.	B
2020-05-28	Male and Female quick couplings switches place.	A
2020-04-30	New document.	-

Readers note:

Indicates instruction.



Represents Hose.

Dashed lines for overview, mounts
on other pages/assemblies.

POS	DESCRIPTION	PART	QTY	COMMENTS
1	Feather Key	650101	6	
2	Screw MC6S M12x80 12.9 ZFSL	6000148	12	Torque: 136Nm

POS in order of assembly

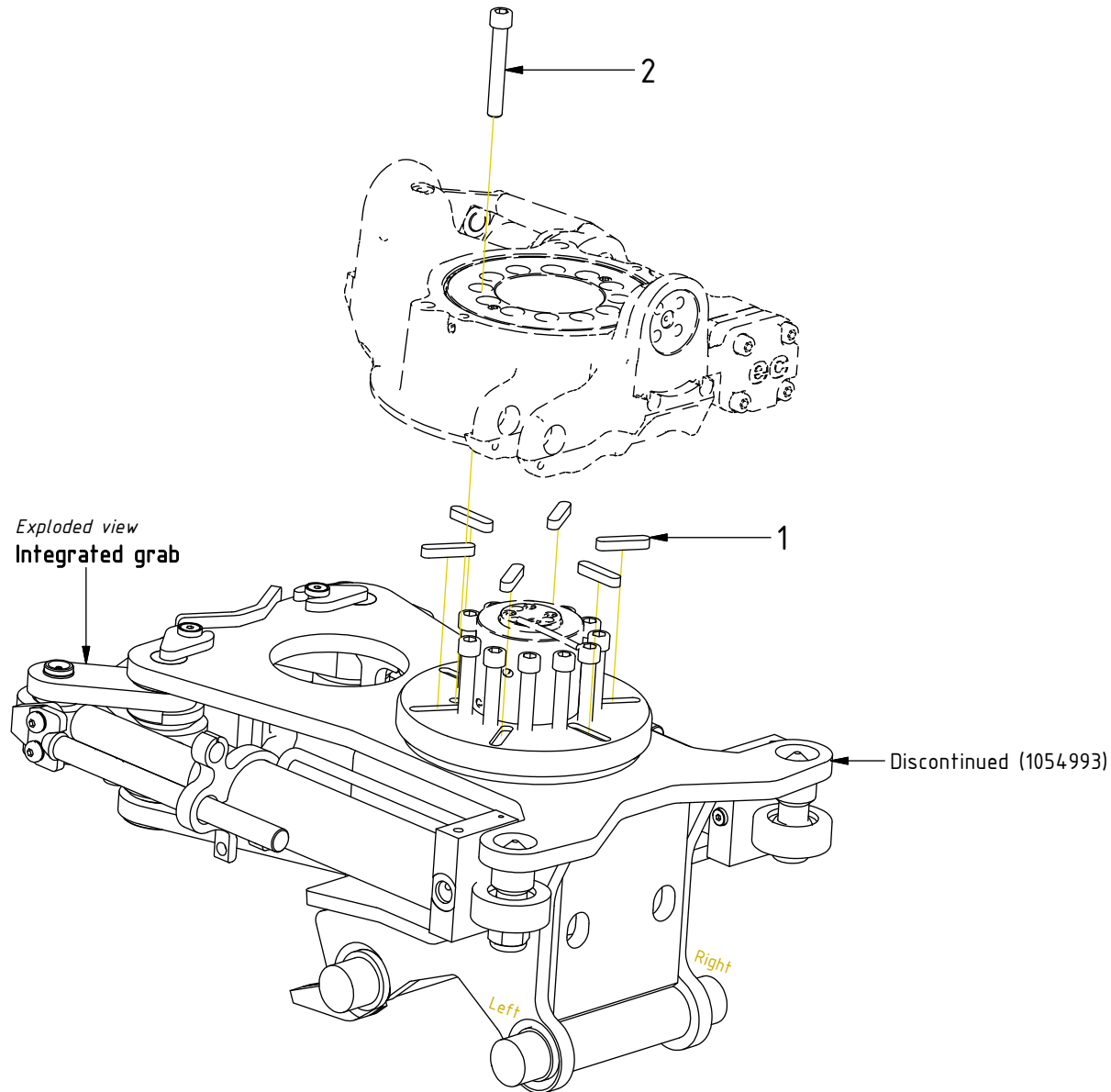

POS in order of assembly

POS	DESCRIPTION	PART	QTY	COMMENTS
3	Adapter 401-02-02 90° (1/8")	710293	1	
4	Washer GBR04 1/4	710702	8	QTY: 4 part of Integrated grab
5	Adapter 136-04-04 (1/4")	7000531	2	
6	Washer GBR02 1/8	710701	2	
7	Hose Lock Close	7001382	1	
8	Banjo bolt 4451-02 (1/2")	710277	1	
9	Hose Lock Open	7001381	1	
10	Hose Grab Internal	7000141	2	
11	Adapter 853-04-99 (1/4")	710184	2	
12	Hose Grab Long	7000112	2	
13	Hose Grab Short	7000113	2	
14	Quick Coupler 1/4" Male 2520	790111	2	
15	Quick coupler 1/4" 2510 cejn	790110	2	
16	Adapter 401-04-04 90° (1/4")	710151	1	
17	Adapter 45° 402-04-04(1/4")	7000104	1	
18	Adapter 138-04-29 (1/4")	710135	4	Part of Integrated grab

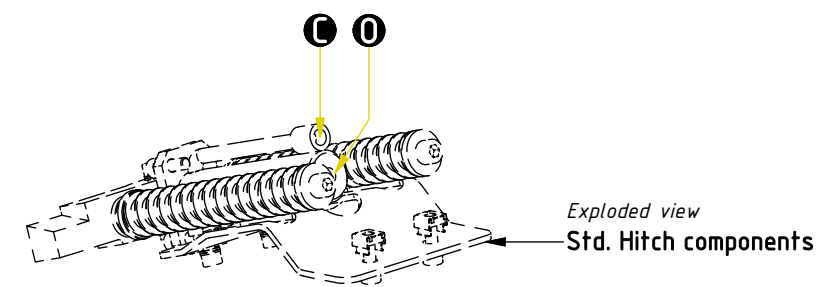
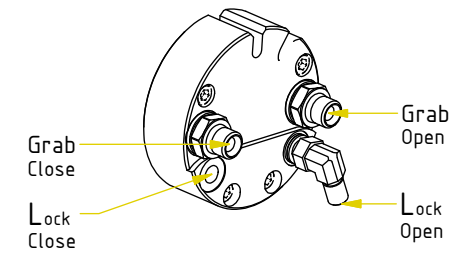
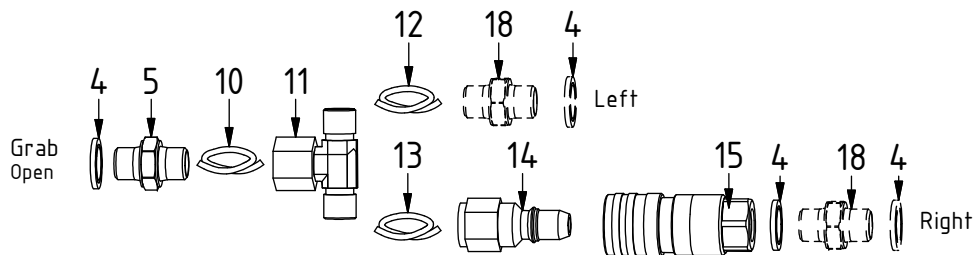
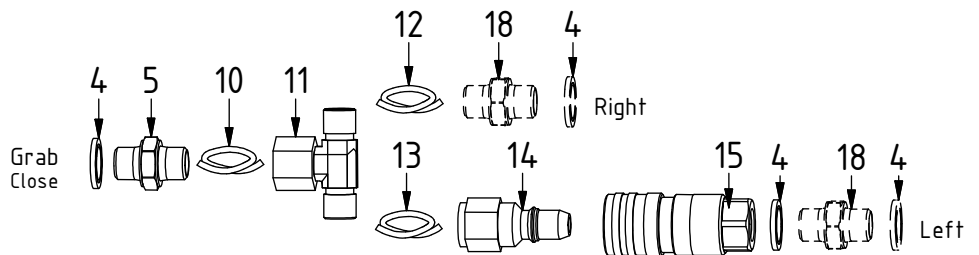
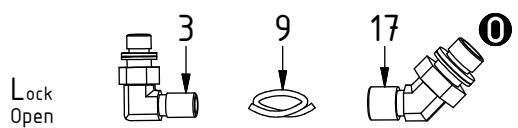
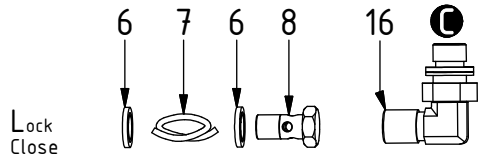

POS	DESCRIPTION	PART	QTY	COMMENTS
7	Hose Lock Close	7001382	1	
9	Hose Lock Open	7001381	1	
10	Hose Grab Internal	7000141	2	
12	Hose Grab Long	7000112	2	
13	Hose Grab Short	7000113	2	

