

## COVERSHEET

### Planned document changes:

**Briefly:**

No planned changes.

### Document changes:

Date:	Change:	Rev. after change:
2024-09-02	Screws updated to ZFSHL. Spare parts updated.	B
2022-02-21	O-rings updated.	A
2018-09-10	New spare parts document, EC30 replaced by EC233.	-

*Readers note:*



Indicates instruction.



Represents Hose.

Dashed lines for overview, mounts on other pages/assemblies.

POS in order of assembly

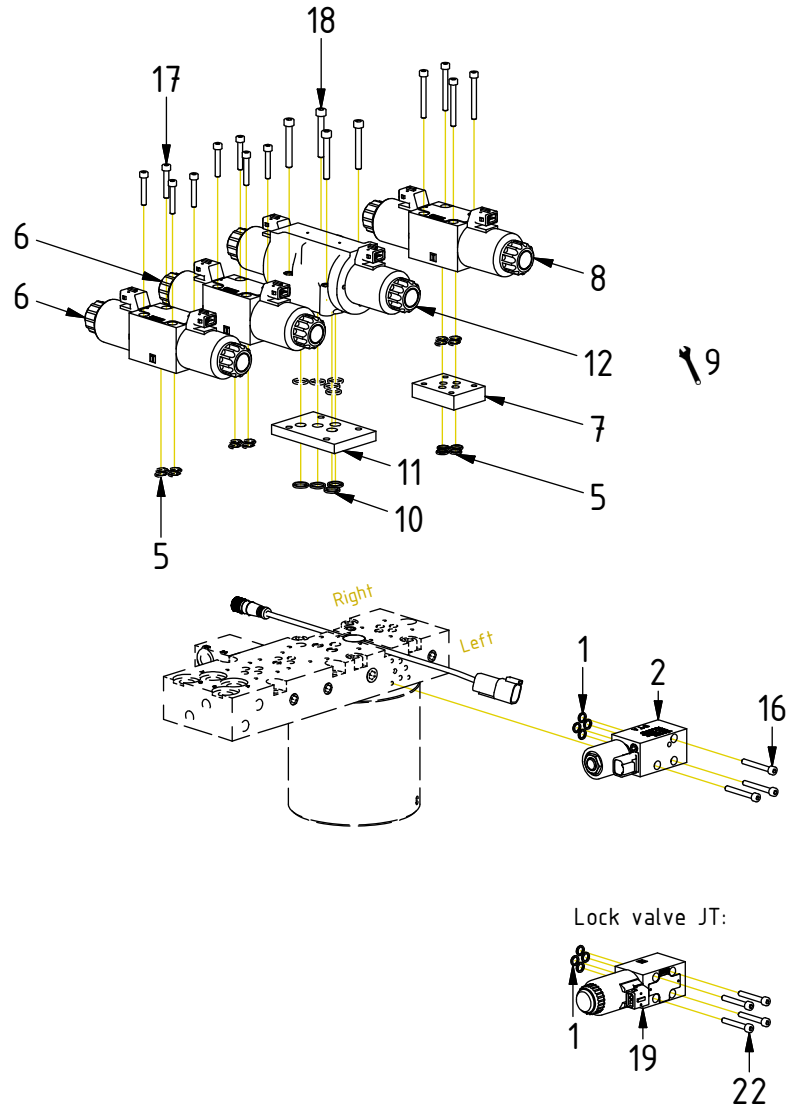

POS	DESCRIPTION	PART	QTY	COMMENTS
1	O-ring 7,65x1,78	710960	4	
2	Directional valve NG4 IQS 24V DT	1042190	1	For QS, CW, ECPUP, ss SIQ (POS.1, 3, 4 incl.)
3	Coil IQS 24V DT	1042066	1	
4	Nut 1270-04	710250	1	
5	O-ring 9,25x1,78	710901	12	
6	Directional valve NG6 prop 12V	730190	2	(POS.5, 13, 15 incl.)
7	Shim block NG6 15mm	1037260	1	
8	Directional valve NG6 24V	730103	1	(POS.5, 14, 15 incl.)
9	For option PROP on grab/extra			See p.10 for instruction
10	O-ring square 12,42x1,68	750704	9	
11	Shim block NG10	1036293	1	
12	Directional valve NG10 24V	730339	1	(POS.10, 14, 15 incl.)
13	Coil 12V prop JT	730192	4	
14	Coil 24V JT	730118	4	
15	Nut directional valve	730135	8	
16	Screw MC6S M5x40 12.9	610405	3	Torque: 9,7Nm
17	Screw MC6S M5x30 12.9	610403	8	Torque: 9,7Nm
18	Screw MC6S M6x45 12.9	6000080	4	Torque: 17Nm
19	Directional valve NG4 Lock 24V	730310	1	(POS.1, 20, 21 incl.)
20	Coil NG4 24V JT	730311	1	
21	Nut directional valve NG4	1006785	1	
22	Screw MC6S M5x35 12.9	610404	4	Torque: 9,7Nm

# EC30 ECHF - Valves & cables ss10 (DC2/SVAB)

## Cables DC2

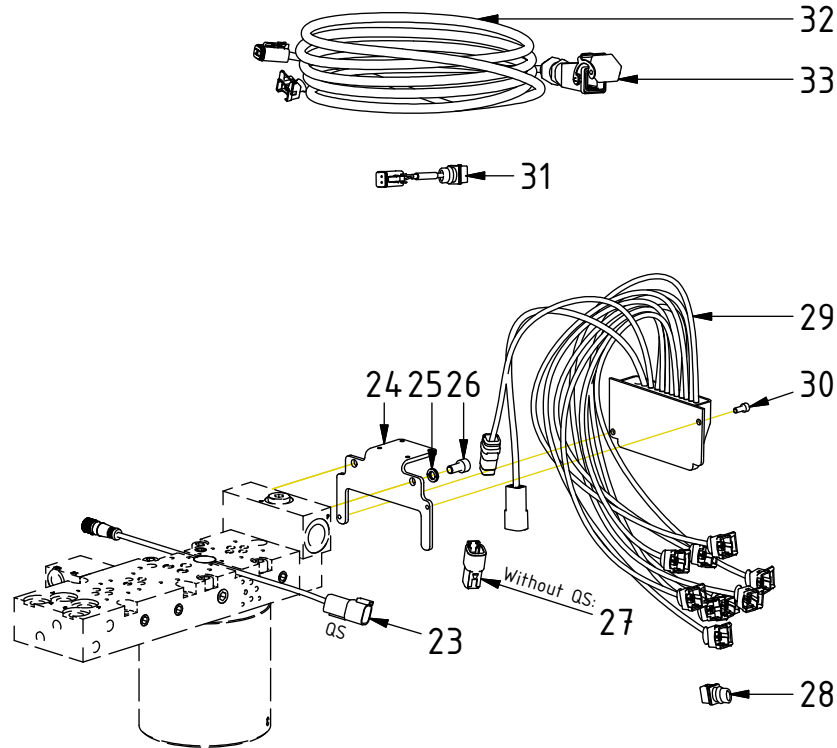

POS	DESCRIPTION	PART	QTY	COMMENTS
23	Only for QS, connector			
24	Fastening plate DC2, EC30 ECHF	1037259	1	
25	Washer NL 8mm	611040	2	
26	Screw MC6S M8x16 12.9 Geomet	610432	2	
27	DTM Protection plug	8000090	1	
28	JT Jumper QSC connected	1018662	1	Plug JT connector "1"
29	Tiltrotator module DC2 Q-Safe	842137	1	
30	Screw MC6S M5x12 12.9	6000077	2	
31	Adapter cable DT-JT (Lockvalve DT)	1017478	1	For QS, CW, ECPUP, ss SIQ
32	Aggregate cable DC2 Comp. QSC JT	8000175	1	
33	ILME cover	810208	1	(Incl. with agg.cable)
34	Adapter cable ECO W DC2 DTM	1042249	1	For EC-Oil. Instead of POS.31-32
35	Adapter cable ECO W DC2 DTM QSC	1044790	1	For EC-Oil. Instead of POS.31-32
36	Adapter cable DC2 ePS	8000783	1	
37	Adapter cable ePS rotation sensor	8000784	1	
38	Bracket ePS1	1038119	1	For Topcon/LEICA/Novatron
39	Bracket ePS1 (Trimble only)	1038117	1	For Trimble
40	Screw MC6S M5x10 12.9	610594	4	
41	Protection plate End lock EC30	1029734	1	
42	Washer NL 10mm	611041	3	
43	Screw MC6S M10x40 12.9 ZFSHL	612020	3	

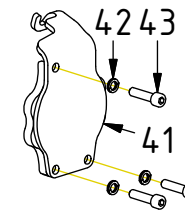

ePS1:

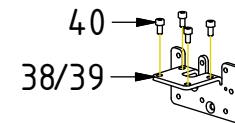
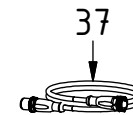
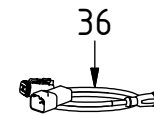

EC-Oil:

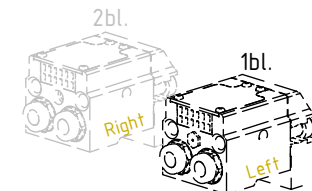
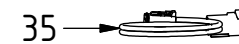

Exploded view  
EC-Oil components

POS in order of assembly

# EC30 ECHF - Valves & cables ss10 (DC2/SVAB)

## Cables

ss10 (SVAB)

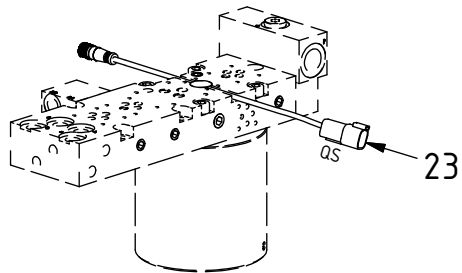
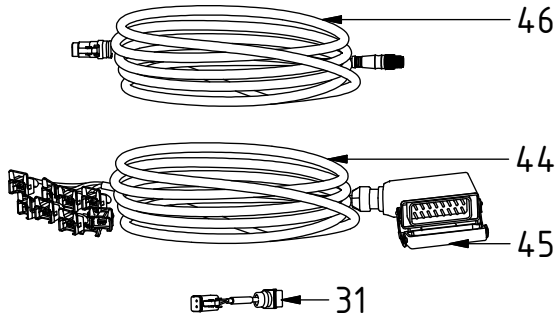

POS	DESCRIPTION	PART	QTY	COMMENTS
23	Only for QS, connector			
31	Adapter cable DT-JT (Lockvalve DT)	1017478	1	For QS, CW, ECPUP, ss SIQ
37	Adapter cable ePS rotation sensor	8000784	1	
38	Bracket ePS1	1038119	1	For Topcon/LEICA/Novatron
39	Bracket ePS1 (Trimble only)	1038117	1	For Trimble
40	Screw MC6S M5x10 12.9	610594	4	
41	Protection plate End lock EC30	1029734	1	
42	Washer NL 10mm	611041	3	
43	Screw MC6S M10x40 12.9 ZFSHL	612020	3	
44	Aggregate cable SVAB Complete	1015196	1	
45	ILME cover 16P	810235	1	(Incl. with agq.cable)
46	Cable QS QLM tiltrotator SVAB	842148	1	For QS
47	Adapter cable ECO (DTM) SVAB	1029599	2	For EC-Oil. Instead of POS.31,44,46
48	Adapter cable DT>JT (Lockvalve JT)	8001989	1	For Left adapter cable
49	Unit cable ePS w. 120 ohm termin.	8000824	1	

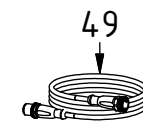
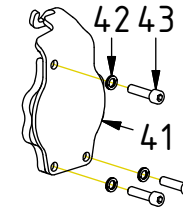

ePS1:

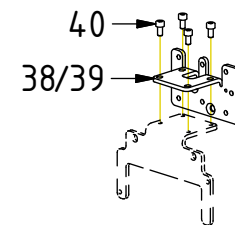
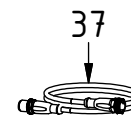

EC-Oil:

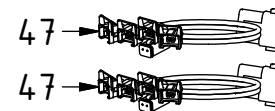

Lock valve JT:

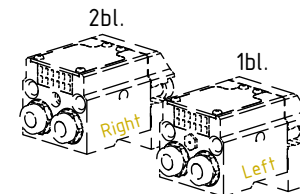
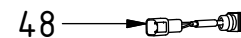

Exploded view

EC-Oil components

POS in order of assembly

# EC30 ECHF - Valves & cables ss10 (DC2/SVAB)

## Cables

(NB: photos reused from other models)

DC2 without EC-Oil

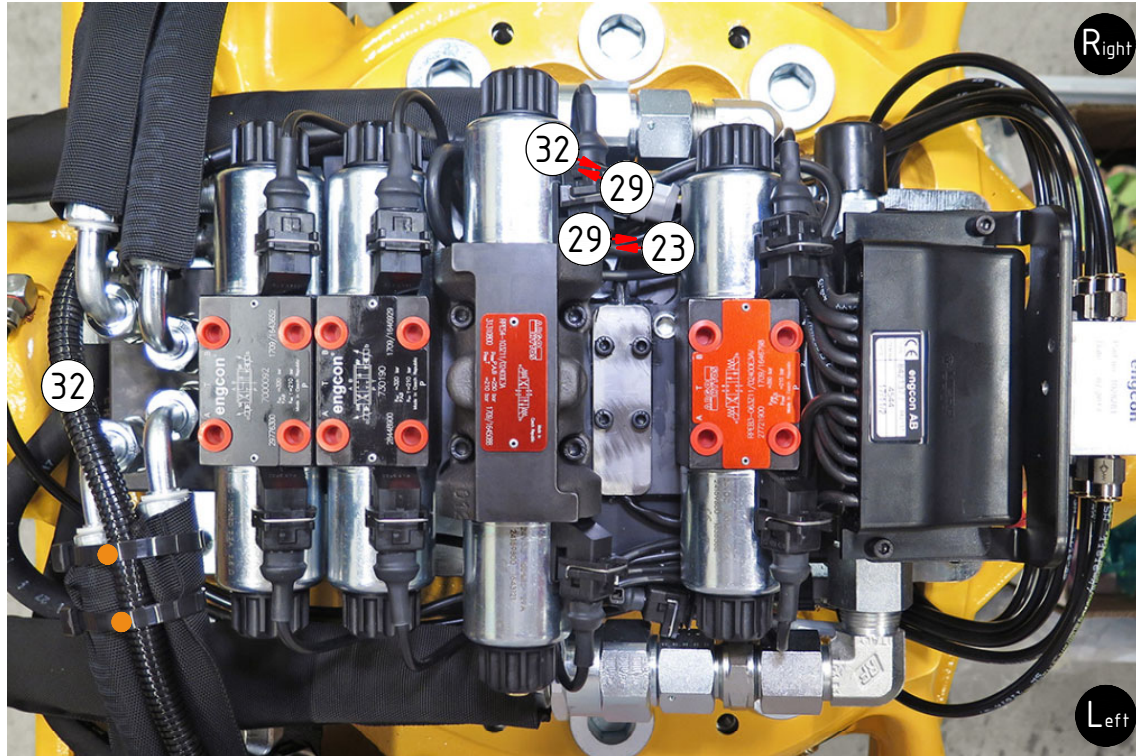

DC2 EC-Oil

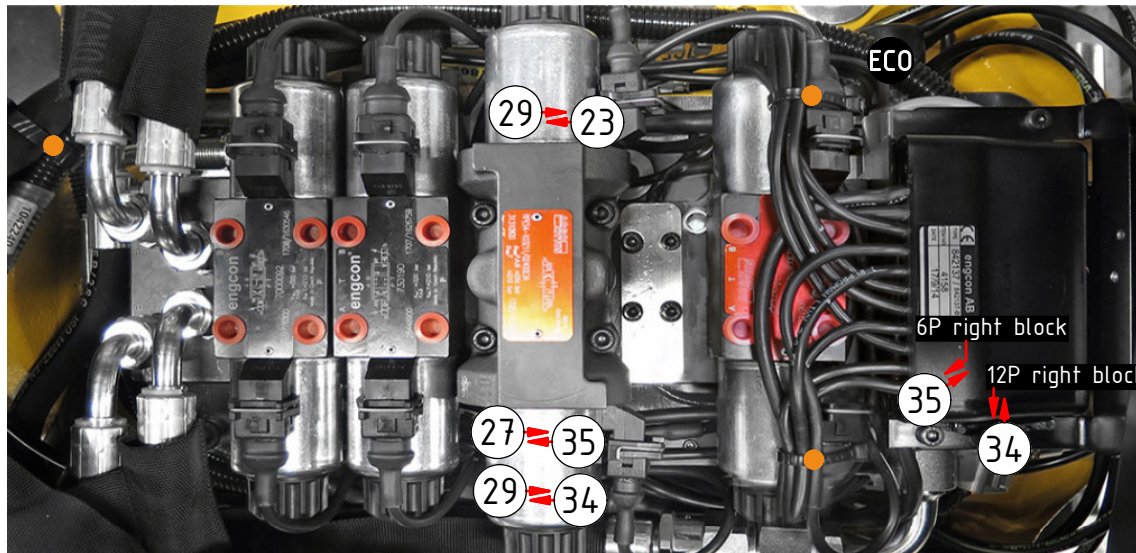

DC2 EC-Oil & ePS

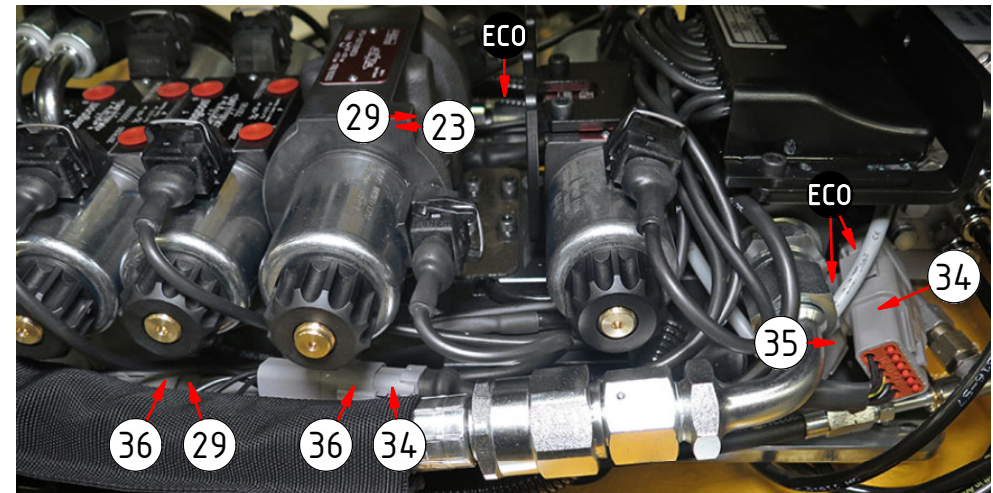

Continue to page 6 for ePS specifics, connecting to sensor etc.

POS	DESCRIPTION	PART	QTY	COMMENTS
23	Only for QS, connector			
27	DTM Protection plug	8000090	1	
29	Tiltrotator module DC2 Q-Safe	842137	1	
32	Aggregate cable DC2 Comp. QSC JT	8000175	1	
34	Adapter cable ECO W DC2 DTM	1042249	1	For EC-Oil. Instead of POS.31-32
35	Adapter cable ECO W DC2 DTM QSC	1044790	1	For EC-Oil. Instead of POS.31-32
36	Adapter cable DC2 ePS	8000783	1	
●	Use cable ties			

POS in order of assembly

# EC30 ECHF - Valves & cables ss10 (DC2/SVAB)

Cables  
DC2 ePS

(NB: photos reused from other models)

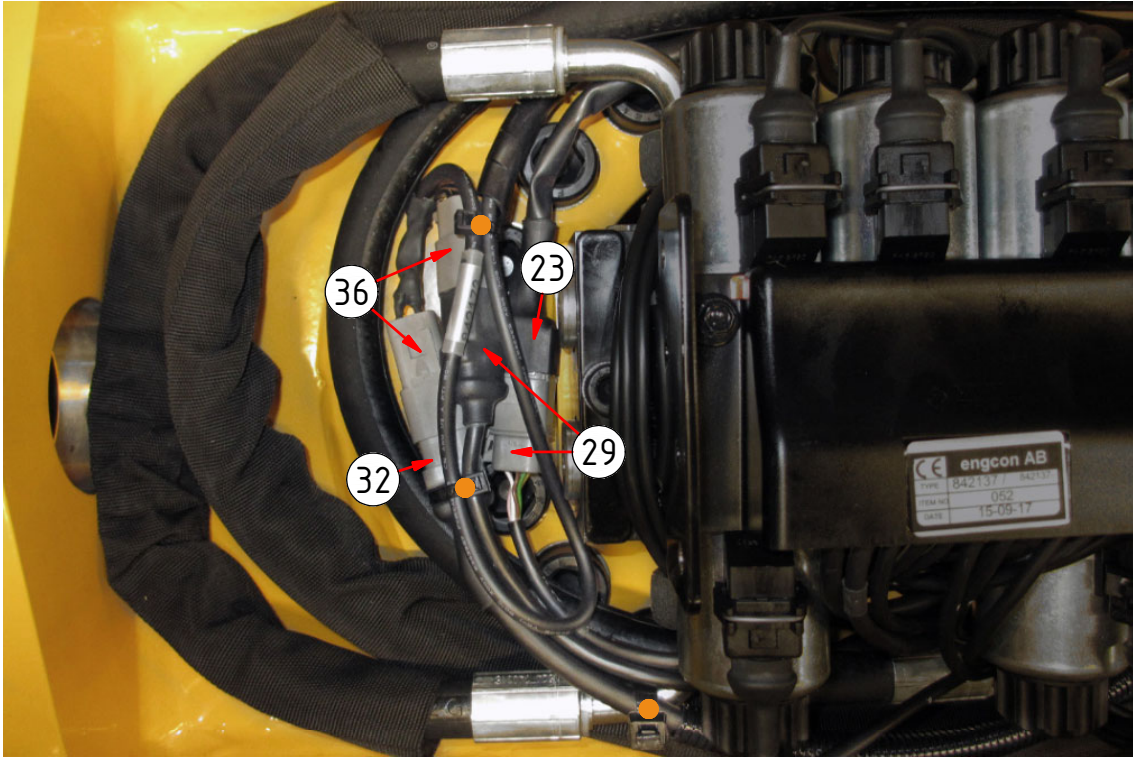

POS	DESCRIPTION	PART	QTY	COMMENTS
23	Only for QS, connector			
29	Tiltrotator module DC2 Q-Safe	842137	1	
32	Aggregate cable DC2 Comp. QSC JT	8000175	1	
36	Adapter cable DC2 ePS	8000783	1	
37	Adapter cable ePS rotation sensor	8000784	1	
●	Use cable ties			

POS in order of assembly

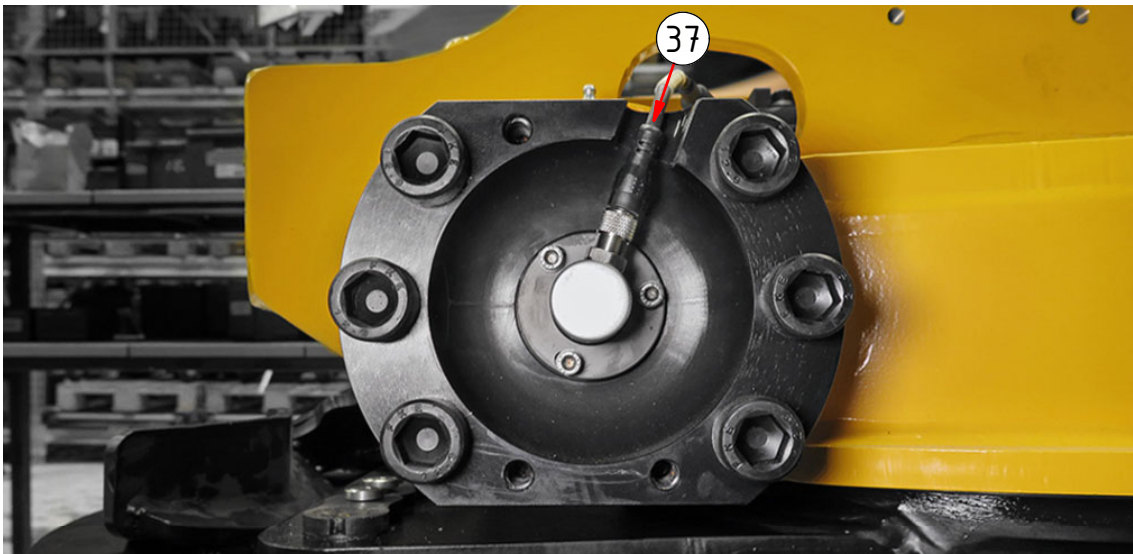

## Cables

(NB: photos reused from other models)

ss10 (SVAB) EC-Oil

POS	DESCRIPTION	PART	QTY	COMMENTS
23	Only for QS, connector			
27	DTM Protection plug	8000090	1	
47	Adapter cable ECO (DTM) SVAB	1029599	2	For EC-Oil. Instead of POS.31,44,46
●	Use cable ties			

POS in order of assembly

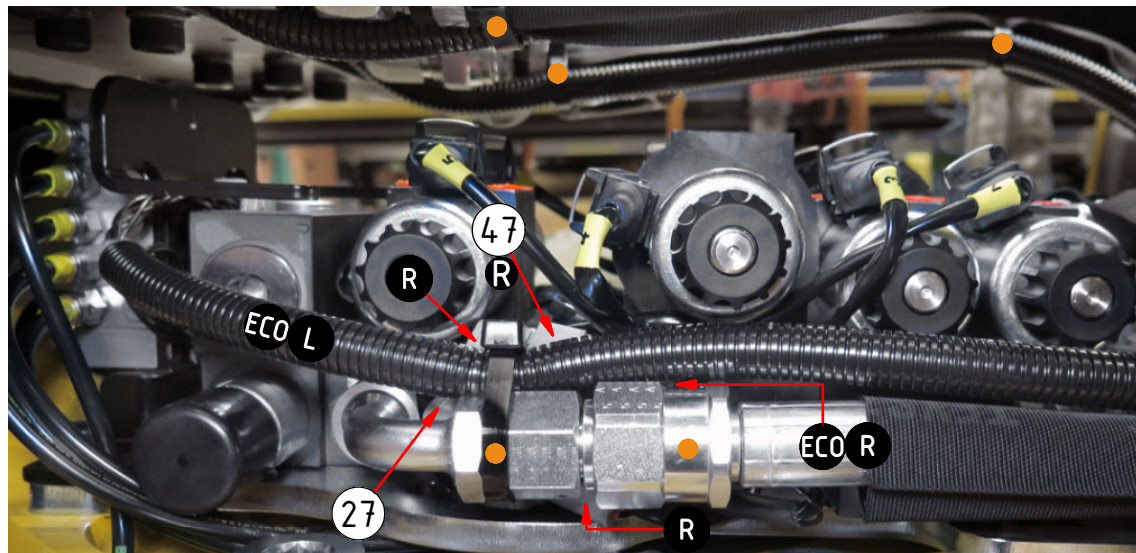
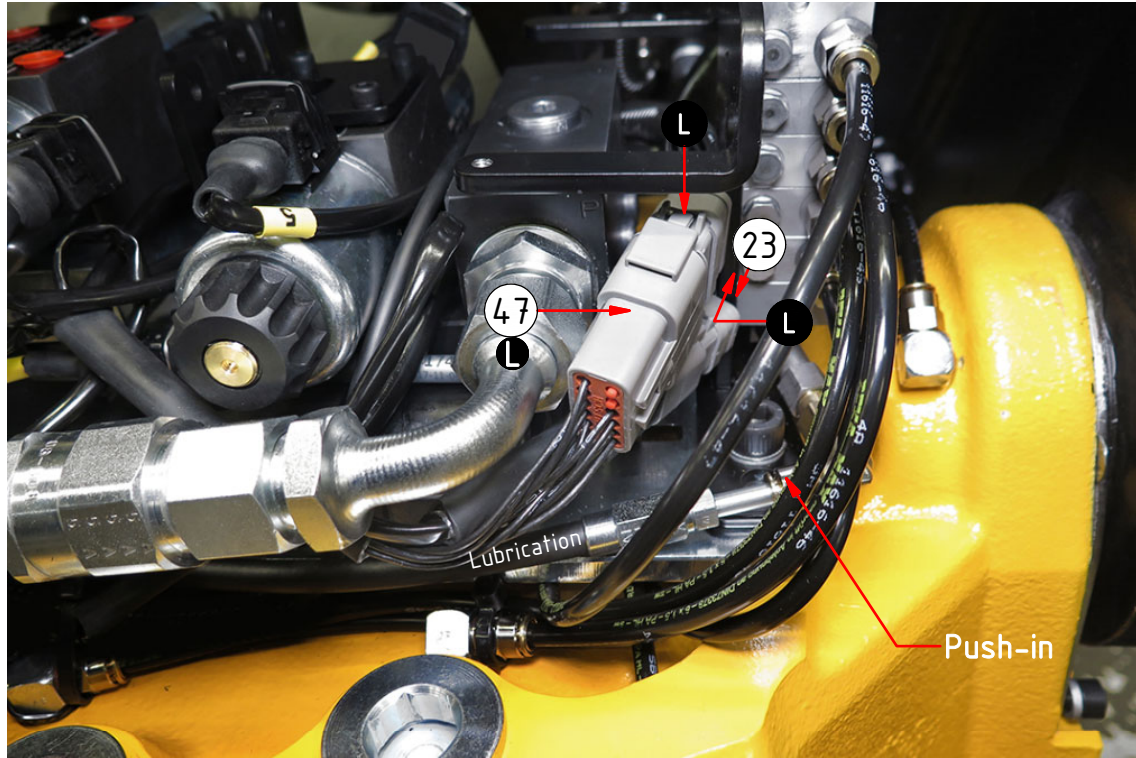

# EC30 ECHF - Valves & cables ss10 (DC2/SVAB)

## Cables

(NB: photos reused from other models)

ss10 (SVAB) ePS

POS	DESCRIPTION	PART	QTY	COMMENTS
23	Only for QS, connector			
37	Adapter cable ePS rotation sensor	8000784	1	
44	Aggregate cable SVAB Complete	1015196	1	
46	Cable QS QLM tiltrotator SVAB	842148	1	For QS
49	Unit cable ePS w. 120 ohm termin.	8000824	1	
●	Use cable ties			

POS in order of assembly

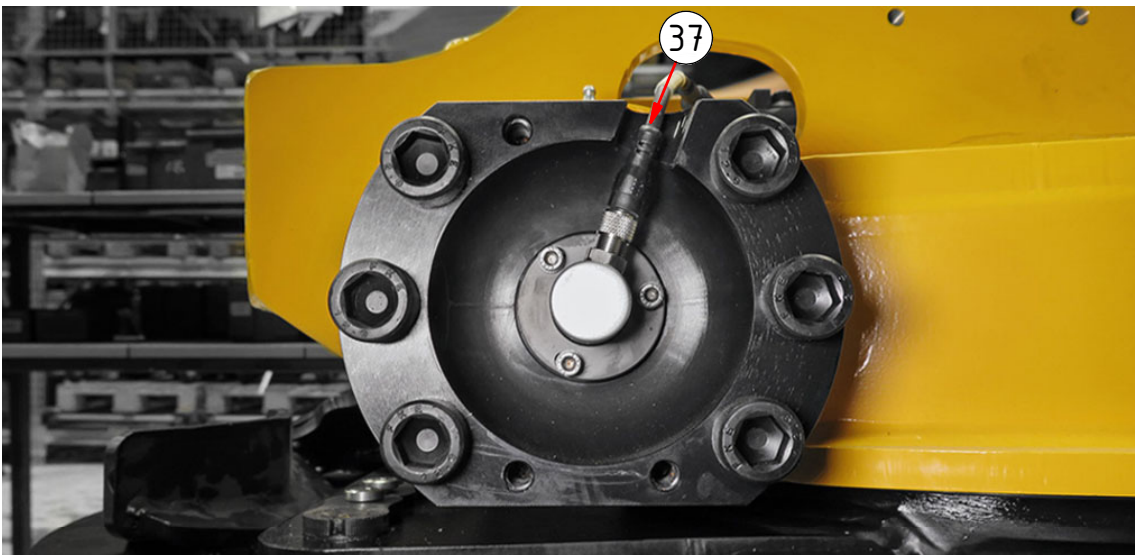
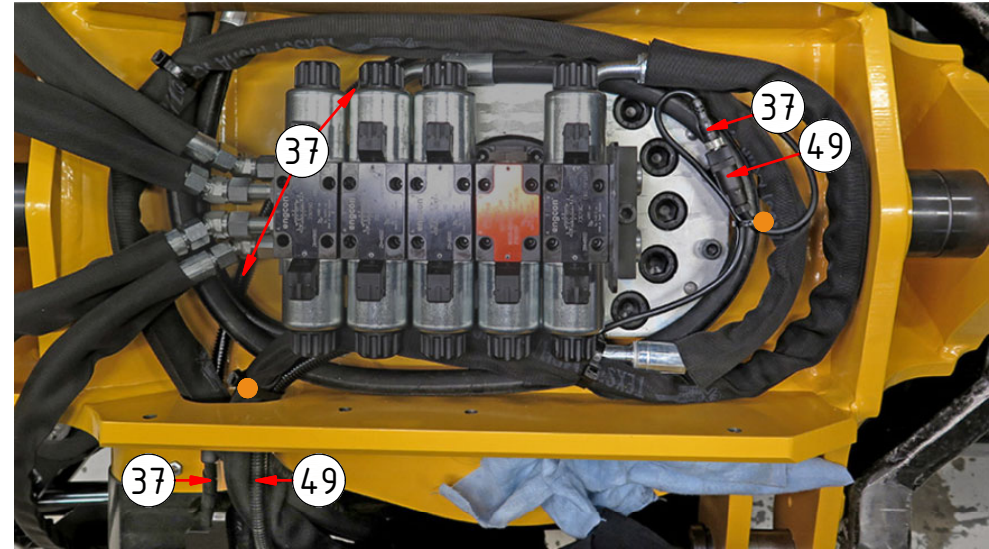
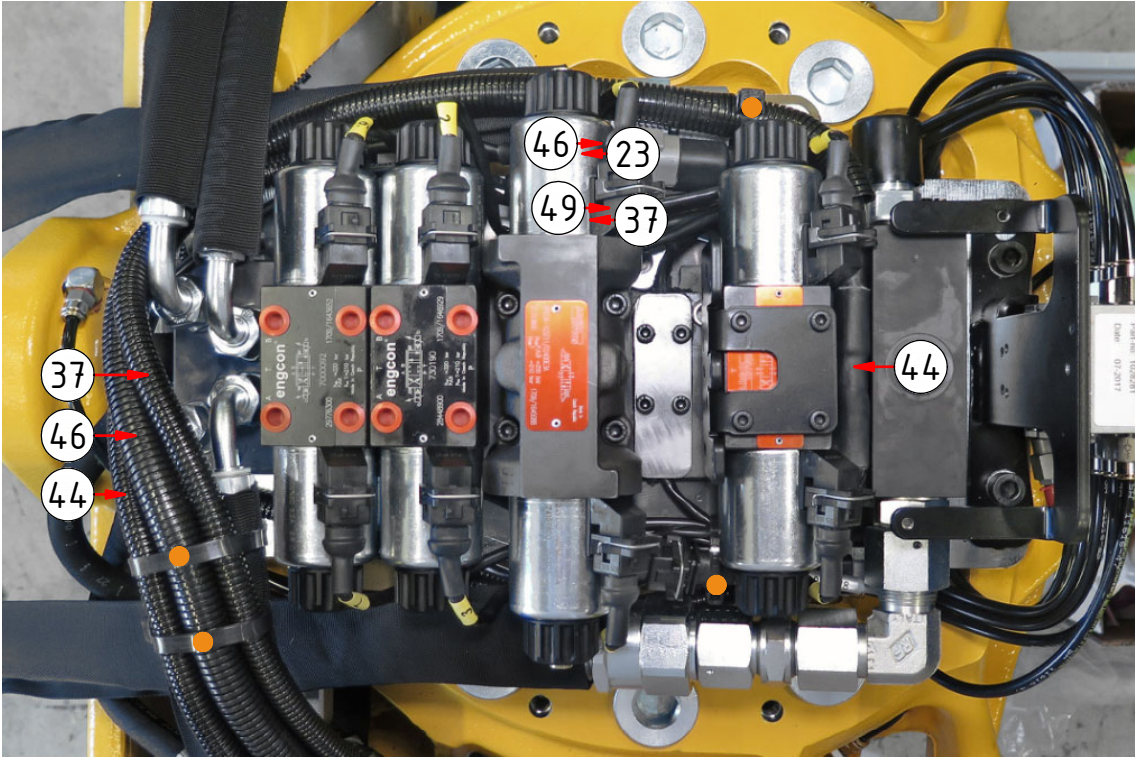



## Valves

(NB: photos reused from other models)

POS	DESCRIPTION	PART	QTY	COMMENTS
9	For option PROP on grab/extra			See p.10 for instruction

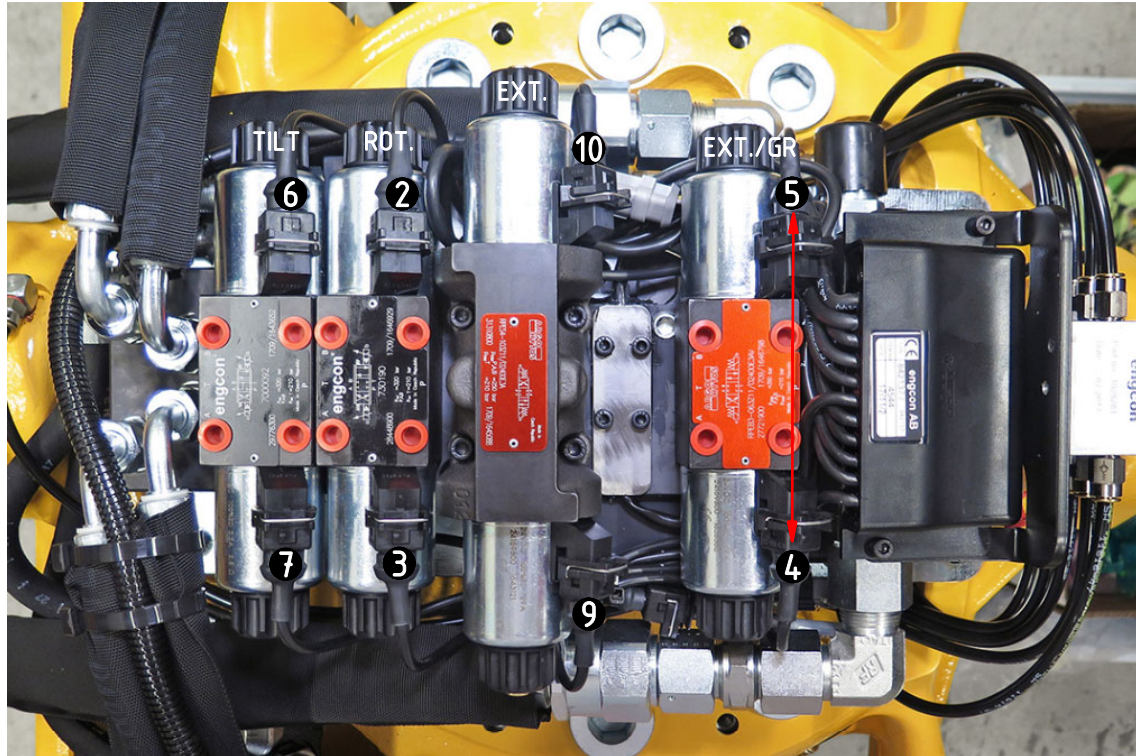

4 & 5 switches place when **NOT** equipped to hold a grab adapter or grab cassette.

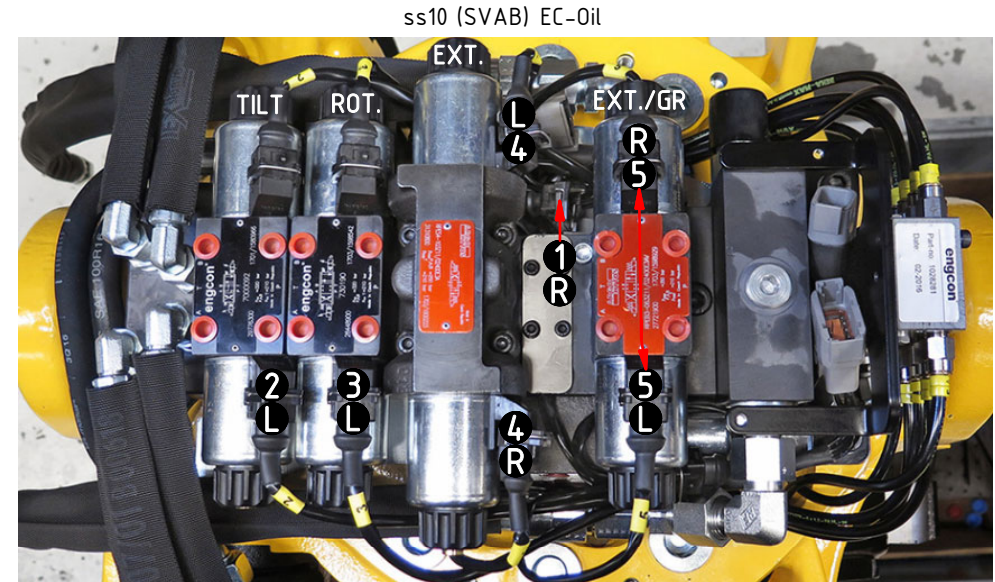

5 & 5 switches place when **NOT** equipped to hold a grab adapter or grab cassette.

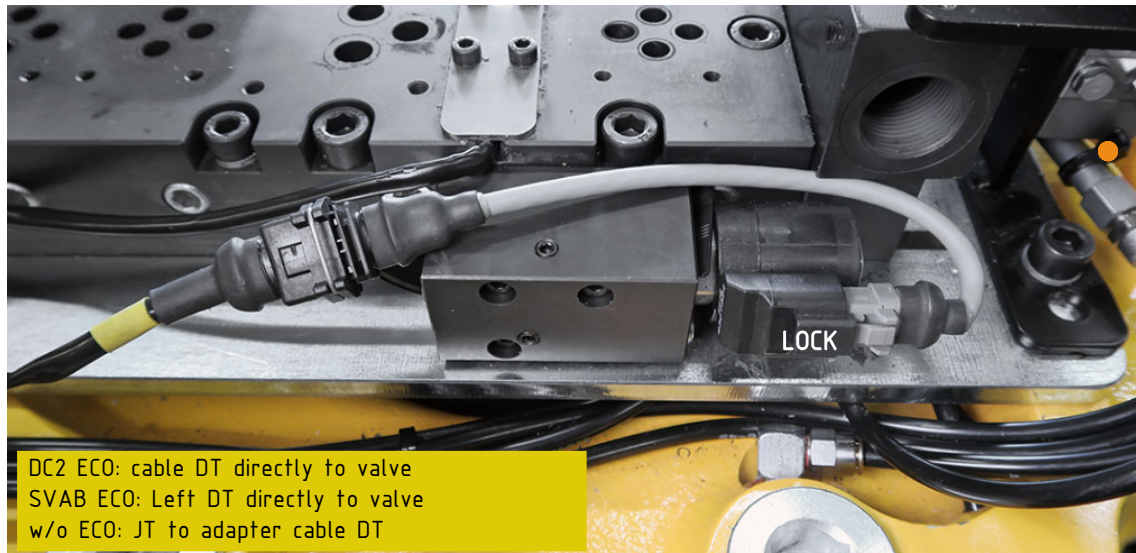

DC2 ECO: cable DT directly to valve  
 SVAB ECO: Left DT directly to valve  
 w/o ECO: JT to adapter cable DT

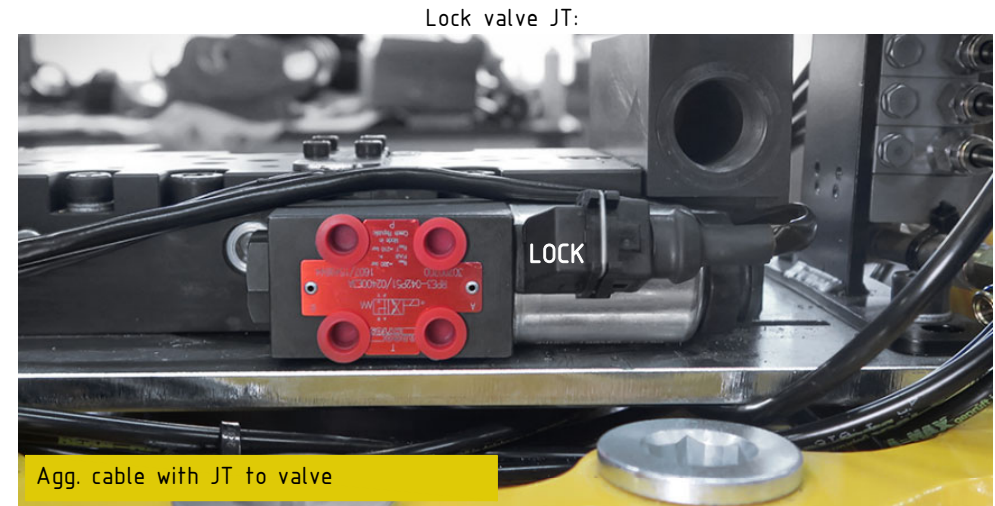

Agg. cable with JT to valve

POS in order of assembly

special/options

(NB: photos reused from other models)

POS	DESCRIPTION	PART	QTY	COMMENTS
6	Directional valve NG6 prop 12V	730190	2	(POS.5, 13, 15 incl.)
10	O-ring square 12,42x1,68	750704	9	
17	Screw MC6S M5x30 12.9	610403	8	Torque: 9,7Nm
50	Adapter plate NG10-NG6	7000147	1	
51	Screw MC6S 6x25	6000083	4	Torque: 17Nm

POS in order of assembly

PROP valve on grab/extra

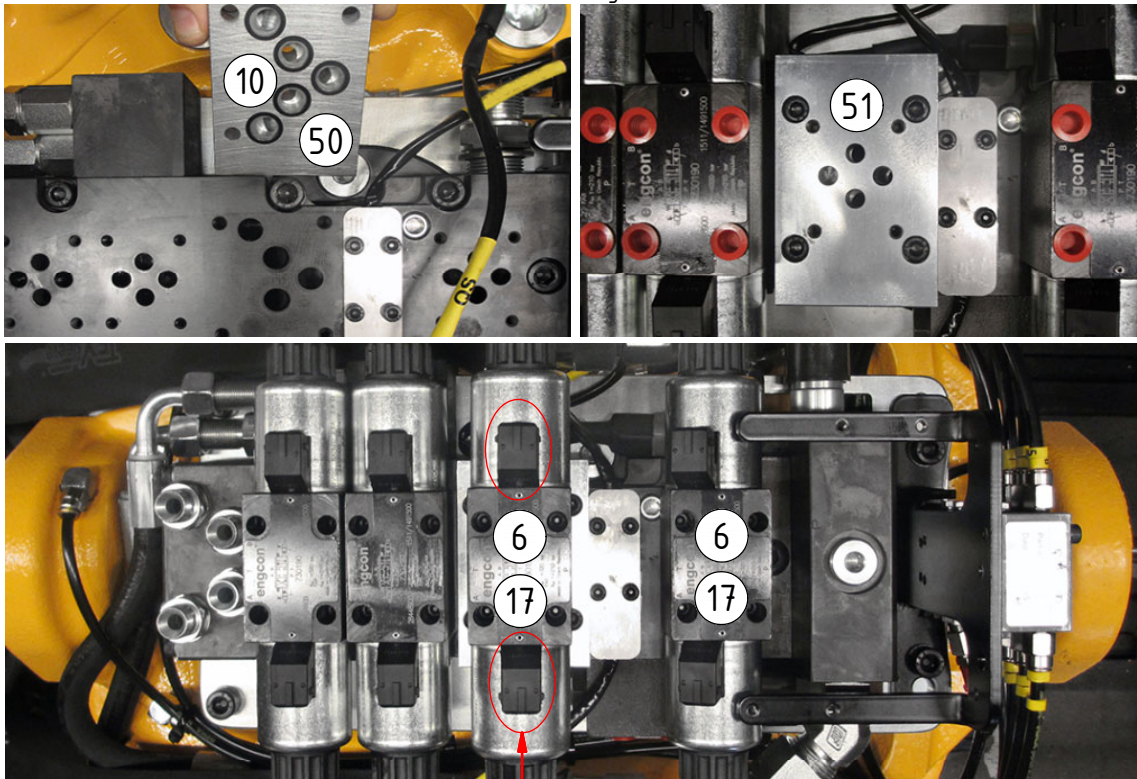

NB! Connectors for valves as standard config. *except* the connectors on EXTRA switches place as encirkled.

## SPARE PARTS

POS	DESCRIPTION	PART	QTY	COMMENTS
29	Tiltrotator module DC2 Q-Safe	842137	1	
32	Aggregate cable DC2 Comp. QSC JT	8000175	1	
33	ILME cover	810208	1	(Incl. with agg.cable)
35	Adapter cable ECO W DC2 DTM QSC	1044790	1	For EC-Oil. Instead of POS.31-32
36	Adapter cable DC2 ePS	8000783	1	
37	Adapter cable ePS rotation sensor	8000784	1	
49	Unit cable ePS w. 120 ohm termin.	8000824	1	
52	Adapter cable DC2 ePS DT DT M12	842173	1	Replaced by POS.36 from 2019-10
53	Agg. cable SVAB ePS rot. sensor	842187	1	Replaced by POS.49 from 2019-10
54	Adap. cable SVAB ePS rot. sensor	842188	1	Replaced by POS.37 from 2019-10
55	Adapter cable Lock ECO DC2 QSC	1042250	1	Replaced by POS.35 from 2017-10

DC2



Replaced by POS.32 from 2018-01

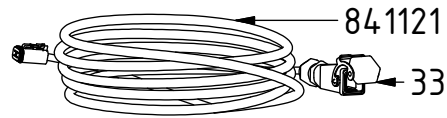

Replaced by POS.29 from 2016-03

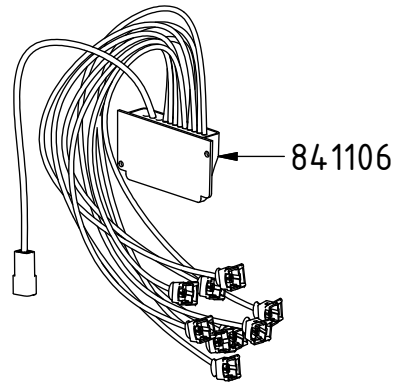

SVAB (ss10) ePS:

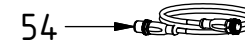
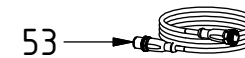

DC2 EC-Oil QSC:



POS in order of assembly

## SPARE PARTS

### MACS

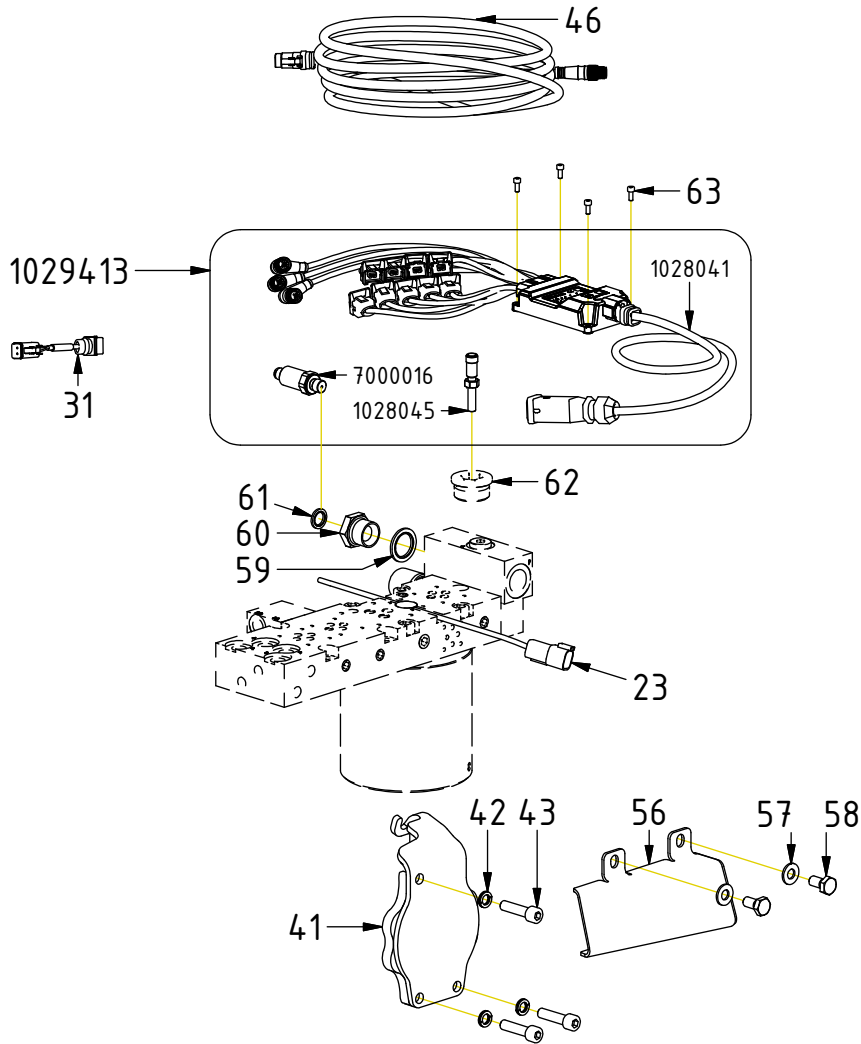

POS	DESCRIPTION	PART	QTY	COMMENTS
23	Only for QS, connector			
31	Adapter cable DT-JT (Lockvalve DT)	1017478	1	For QS, CW, ECPUP, ss SIQ
41	Protection plate End lock EC30	1029734	1	
42	Washer NL 10mm	611041	3	
43	Screw MC6S M10x40 12.9 ZFSHL	612020	3	
46	Cable QS QLM tiltrotator SVAB	842148	1	For QS
56	Protection sensor MACS-EC30	1033690	1	
57	Washer BRB 10,5x22x2 200 HV FZB	611006	2	
58	Screw M6S M10x20 8,8 FZB	610141	2	
59	Washer GBR12 3/4	710706	1	
60	Adapter 234-12-04	7000115	1	
61	Washer GBR04 1/4	710702	1	Used as shim if required
62	RP M36x2/M8x1 MACS	650411	1	
63	Screw MC6S M4x10 8,8 FZB	610523	4	
64	Adapter cable ECO W MACS-DTM	1043277	1	For ECO. Instead of 1028041+POS.46

POS in order of assembly

### EC-Oil:

